

HZALJ Hi-Lumen LED

LED area lighting for hazardous locations



Classifications

- Class I, Division 2, Groups A, B, C & D
- Class II, Divisions 1 & 2, Groups E, F & G
- Class III
- Class I, Zone 2, Group IIA, IIB, IIC
- UL 1598A Marine Outside Type
- UL 1598 Wet Locations
- UL 8750 LED Safety
- UL 844 Hazardous Locations
- -40°C to 65°C Ambient Temperature
- CSA C22.2 No. 250.0-08
- CSA C22.2 No. 137-M1981 (R2014)

- NEMA 4X
- ABS Type Approved
- IP66
- Tested to LM 79, LM 80
- Factory Sealed
- Buy American Act (BAA) Compliant

IECEX

- Ex ec nC IIC T3 Gc
- -40°C ≤ Tamb ≤ 65°C, IP66
- Ex tb IIIC T135°C Db
- -40°C ≤ Tamb ≤ 65°C, IP66
- Certificate: IECEX UL 20.0110X

ATEX

- CE  II 3 G
- II 3 G Ex ec nC IIC T3 Gc
- -40°C ≤ Tamb ≤ 65°C, IP66
- Certificate: UL 20 ATEX 2435X
- CE  II 2 D
- II 2 D Ex tb IIIC T135°C Db
- -40°C ≤ Tamb ≤ 65°C, IP66
- Certificate: UL 20 ATEX 2434X



availinfra.com/rig-a-lite

8500 Hansen Road
Houston, TX 77075
(713) 943-0340

HZALJ Hi-Lumen LED

LED area lighting for hazardous locations

Key Features

- 1 Low profile body, less than 11" high
- 2 Interchangeable optics with Type I, III, V and wide distribution options
- 3 Spring pressure connection terminal block
- 4 Field replaceable LED circuit boards and drivers with quick disconnects
- 5 Hinged mount for access to internal components
- 6 Optional trunnion mount with locking positions in 15 degree increments
- 7 Two (2) safety cable attachment points

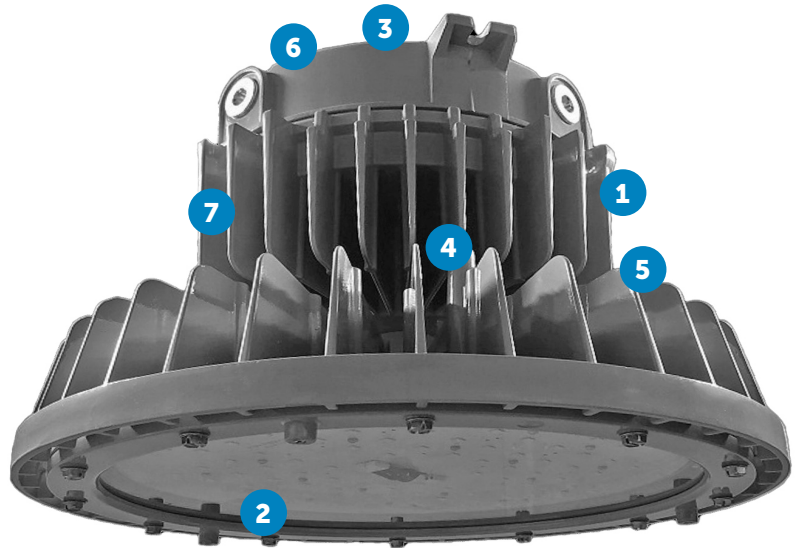

Additional Features

- Pendant, ceiling, wall, trunnion and stanchion mounting options
- Mates directly to select competitor mounts
- Dimming option
- Optional Type 316 stainless steel guard
- Standard 10kV surge protection
- 5-year warranty

Standard Materials

- Body:**
A360 aluminum (less than .4% copper content)
with baked-on gray epoxy finish
- Gaskets:**
One-Piece Silicone
- Lens:**
Tempered Glass or Polycarbonate
- Hardware:**
Stainless Steel

HZALJ Hi-Lumen LED

LED area lighting for hazardous locations

Catalog Number Logic

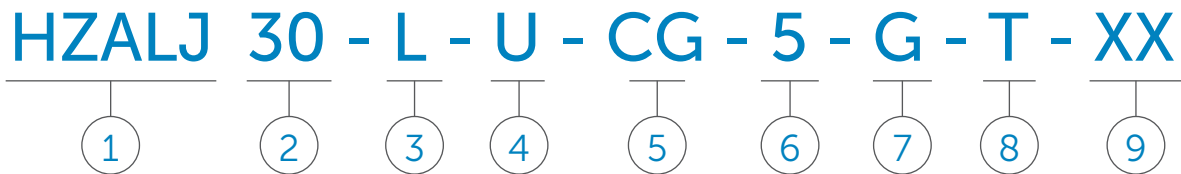

1

BASIC LUMINAIRE

HZALJ = N. American Standards
EXHZALJ = IECEX/ATEX Standards

2

LUMENS/WATTS

15 = 16,450 Lumens / 118 Watts
18 = 19,200 Lumens / 143 Watts
20 = 21,480 Lumens / 163 Watts
23 = 23,590 Lumens / 172 Watts
25 = 26,200 Lumens / 191 Watts
28 = 28,800 Lumens / 219 Watts
30 = 31,720 Lumens / 246 Watts

3

LAMP TYPE

L = LED (5000K CCT - White Light)

4

DRIVER VOLTAGE

U = 120-277V 50/60HZ
N = 347/480V 60HZ

5

LENS

CG = Clear Tempered Glass
FG = Frosted Tempered Glass *
CP = Clear Polycarbonate *

* Not for EXHAZLJ

6

OPTICS

Blank = Type V
1 = Type I
3 = Type III
5 = Type V Wide Beam

7

GUARD

G = Stainless Wire Guard

8

MOUNTING STYLE

P = 3/4" Pendant Mount
P1 = 1" Pendant Mount
C = 3/4" Ceiling Mount
C1 = 1" Ceiling Mount
W = 3/4" Wall Mount
W1 = 1" Wall Mount
T = 3/4" Trunnion Mount
T1 = 1" Trunnion Mount
S = 1-1/4" 25° Stanchion
S1 = 1-1/2" 25° Stanchion
L = 1-1/4" 90° Stanchion
L1 = 1-1/2" 90° Stanchion

9

OPTIONS

SC = Safety Cable
30 = 3000K CCT
40 = 4000K CCT

HZALJ Hi-Lumen LED

LED area lighting for hazardous locations

Certification Guide - HZALJ

Model	Mount	Watts ²	Operating Voltage	Total Lumens ¹	Lumens per Watt ¹	CRI ¹	CCT ¹	Ambient Temperature ^{1,2}	Class I, Div. 2, Groups A, B, C & D	Class II, Div. 1, Groups E, F & G	Supply Wire Suitable Temperature, °C
HZALJ15LU	C, P, T, W, S, L	118W	120-277V 50/60HZ	16,450	139.9	81.0	4933	-40°C < Tamb < 65°C	T3C	T3C	90°C
HZALJ15LN	C, P, T, W, S, L	118W	347/480V 60HZ	16,450	139.9	81.0	4933	-40°C < Tamb < 65°C	T3C	T3C	90°C
HZALJ18LU	C, P, T, W, S, L	143W	120-277V 50/60HZ	19,200	135.1	82.3	5050	-40°C < Tamb < 65°C	T3C	T3C	90°C
HZALJ18LN	C, P, T, W, S, L	143W	347/480V 60HZ	19,200	135.1	82.3	5050	-40°C < Tamb < 65°C	T3C	T3C	90°C
HZALJ20LU	C, P, T, W, S, L	163W	120-277V 50/60HZ	21,480	130.8	82.4	5073	-40°C < Tamb < 65°C	T3C	T3C	90°C
HZALJ20LN	C, P, T, W, S, L	163W	347/480V 60HZ	21,480	130.8	82.4	5073	-40°C < Tamb < 65°C	T3C	T3C	90°C
HZALJ23LU	C, P, T, W, S, L	172W	120-277V 50/60HZ	23,590	135.8	81.9	4863	-40°C < Tamb < 55°C	T3C	T3C	90°C
HZALJ23LN	C, P, T, W, S, L	172W	347/480V 60HZ	23,590	135.8	81.9	4863	-40°C < Tamb < 55°C	T3	T3C	90°C
HZALJ25LU	C, P, T, W, S, L	191W	120-277V 50/60HZ	26,200	134.4	82.0	4881	-40°C < Tamb < 55°C	T3C	T3C	90°C
HZALJ25LN	C, P, T, W, S, L	191W	347/480V 60HZ	26,200	134.4	82.0	4881	-40°C < Tamb < 55°C	T3C	T3C	90°C
HZALJ28LU	C, P, T, W, S, L	219W	120-277V 50/60HZ	28,800	129.7	81.9	4918	-40°C < Tamb < 55°C	T3C	T3C	90°C
HZALJ28LN	C, P, T, W, S, L	219W	347/480V 60HZ	28,800	129.7	81.9	4918	-40°C < Tamb < 55°C	T3C	T3C	90°C
HZALJ30LU	C, P, T, W, S, L	246W	120-277V 50/60HZ	31,720	129.8	82.2	4942	-40°C < Tamb < 55°C	T3C	T3C	90°C
HZALJ30LN	C, P, T, W, S, L	246W	347/480V 60HZ	31,720	129.8	82.2	4942	-40°C < Tamb < 55°C	T3C	T3C	90°C

¹ For CG only, total lumens, lumens per watt, CRI, or CCT may change with CP, FG, or Optics. Consult factory for values.

² Watts, total lumens, and lumens per watt will vary depending on actual ambient temperature.

Certification Guide - EXHZALJ

Model	Mount	Watts ²	Operating Voltage	Total Lumens ¹	Lumens per Watt ¹	CRI ¹	CCT ¹	Ambient Temperature ^{1,2}	Gas Zone 2 Ex ec nC	Dust Zone 21 Ex tb	Supply Wire Suitable Temperature, °C
EXHZALJ15LU	C, P, T, W, S, L	118W	120-277V 50/60HZ	16,450	139.9	81.0	4933	-40°C < Tamb < 65°C	T3	T135°C	90°C
EXHZALJ15LN	C, P, T, W, S, L	118W	347/480V 60HZ	16,450	139.9	81.0	4933	-40°C < Tamb < 65°C	T3	T135°C	90°C
EXHZALJ18LU	C, P, T, W, S, L	143W	120-277V 50/60HZ	19,200	135.1	82.3	5050	-40°C < Tamb < 65°C	T3	T135°C	90°C
EXHZALJ18LN	C, P, T, W, S, L	143W	347/480V 60HZ	19,200	135.1	82.3	5050	-40°C < Tamb < 65°C	T3	T135°C	90°C
EXHZALJ20LU	C, P, T, W, S, L	163W	120-277V 50/60HZ	21,480	130.8	82.4	5073	-40°C < Tamb < 65°C	T3	T135°C	90°C
EXHZALJ20LN	C, P, T, W, S, L	163W	347/480V 60HZ	21,480	130.8	82.4	5073	-40°C < Tamb < 65°C	T3	T135°C	90°C
EXHZALJ23LU	C, P, T, W, S, L	172W	120-277V 50/60HZ	23,590	135.8	81.9	4863	-40°C < Tamb < 55°C	T3	T135°C	90°C
EXHZALJ23LN	C, P, T, W, S, L	172W	347/480V 60HZ	23,590	135.8	81.9	4863	-40°C < Tamb < 55°C	T3	T135°C	90°C
EXHZALJ25LU	C, P, T, W, S, L	191W	120-277V 50/60HZ	26,200	134.4	82.0	4881	-40°C < Tamb < 55°C	T3	T135°C	90°C
EXHZALJ25LN	C, P, T, W, S, L	191W	347/480V 60HZ	26,200	134.4	82.0	4881	-40°C < Tamb < 55°C	T3	T135°C	90°C
EXHZALJ28LU	C, P, T, W, S, L	219W	120-277V 50/60HZ	28,800	129.7	81.9	4918	-40°C < Tamb < 55°C	T3	T135°C	90°C
EXHZALJ28LN	C, P, T, W, S, L	219W	347/480V 60HZ	28,800	129.7	81.9	4918	-40°C < Tamb < 55°C	T3	T135°C	90°C
EXHZALJ30LU	C, P, T, W, S, L	246W	120-277V 50/60HZ	31,720	129.8	82.2	4942	-40°C < Tamb < 55°C	T3	T135°C	90°C
EXHZALJ30LN	C, P, T, W, S, L	246W	347/480V 60HZ	31,720	129.8	82.2	4942	-40°C < Tamb < 55°C	T3	T135°C	90°C

¹ For CG only, total lumens, lumens per watt, CRI, or CCT may change with Optics. Consult factory for values.

² Watts, total lumens, and lumens per watt will vary depending on actual ambient temperature.

HZALJ Hi-Lumen LED

LED area lighting for hazardous locations

Fixture Dimensions (inches)

Pendant Mount

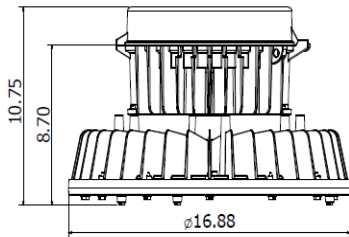

Fixture	Weight
HZALJ15LUCGP	27 lbs.
HZALJ18LUCGP	28 lbs.
HZALJ20LUCGP	28 lbs.
HZALJ23LUCGP	28 lbs.
HZALJ25LUCGP	28 lbs.
HZALJ28LUCGP	29 lbs.
HZALJ30LUCGP	29 lbs.

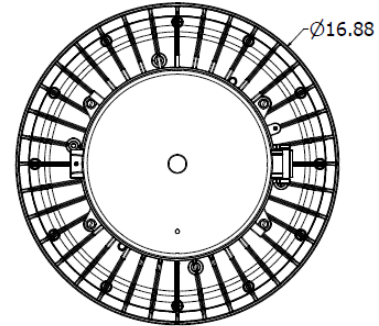

Ceiling Mount

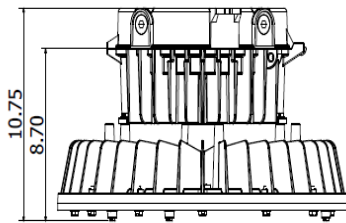

Fixture	Weight
HZALJ15LUCGP	28 lbs.
HZALJ18LUCGP	29 lbs.
HZALJ20LUCGP	29 lbs.
HZALJ23LUCGP	29 lbs.
HZALJ25LUCGP	29 lbs.
HZALJ28LUCGP	30 lbs.
HZALJ30LUCGP	30 lbs.

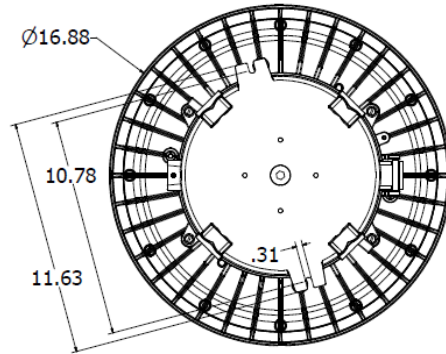

90° Stanchion Mount

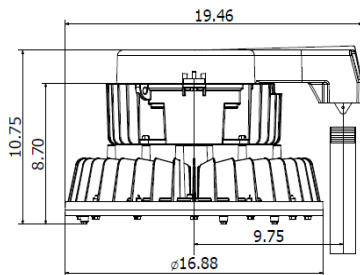

Fixture	Weight
HZALJ15LUCGP	30 lbs.
HZALJ18LUCGP	31 lbs.
HZALJ20LUCGP	31 lbs.
HZALJ23LUCGP	31 lbs.
HZALJ25LUCGP	31 lbs.
HZALJ28LUCGP	32 lbs.
HZALJ30LUCGP	32 lbs.

HZALJ Hi-Lumen LED

LED area lighting for hazardous locations

Fixture Dimensions (inches)

25° Stanchion Mount

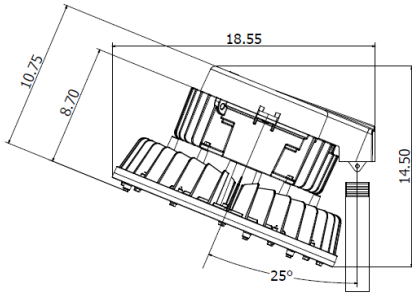

Fixture	Weight
HZALJ15LUCGP	30 lbs.
HZALJ18LUCGP	31 lbs.
HZALJ20LUCGP	31 lbs.
HZALJ23LUCGP	31 lbs.
HZALJ25LUCGP	31 lbs.
HZALJ28LUCGP	32 lbs.
HZALJ30LUCGP	32 lbs.

Trunnion Mount

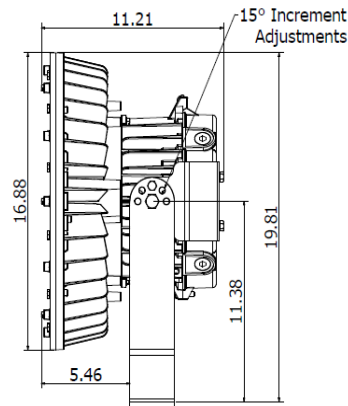



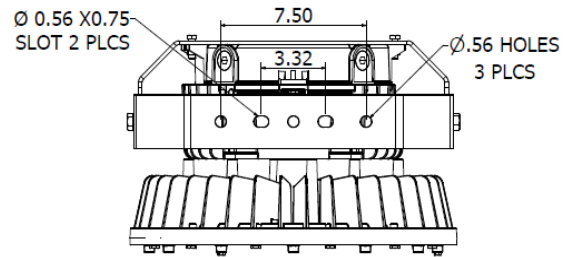

Fixture	Weight
HZALJ15LUCGP	31 lbs.
HZALJ18LUCGP	32 lbs.
HZALJ20LUCGP	32 lbs.
HZALJ23LUCGP	32 lbs.
HZALJ25LUCGP	32 lbs.
HZALJ28LUCGP	33 lbs.
HZALJ30LUCGP	33 lbs.





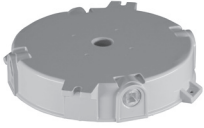

HZALJ Hi-Lumen LED

LED area lighting for hazardous locations

Accessories

Outlet Boxes	Catalog No.	Conduit Hub Size (in.)	Shipping Weight (lbs.)
Rigid Pendant 	JMP	3/4	3.0
	JMP1	1	3.0
Ceiling Mount 	JMC	3/4	3.5
	JMC1	1	3.5
Wall Mount 	JMW	3/4	6.0
	JMW1	1	6.0
Trunnion Mount 	JMT	3/4	8.0
	JMT1	1	8.0
25° Stanchion Mount 	JMS	1-1/4	5.0
	JMS1	1-1/2	5.0
90° Stanchion Mount 	JML	1-1/4	6.5
	JML1	1-1/2	6.5

Lenses	Catalog No.	Conduit Hub Size (in.)	Shipping Weight (lbs.)
	36435	Clear Tempered Glass	2.0
	36436	Frosted Tempered Glass	2.0
	36437	Clear Polycarbonate	2.0

Stainless Steel Wire Guard	Catalog No.	Description	Shipping Weight (lbs.)
	86335	Stainless Steel	1.0

Stainless Steel Safety Cable	Catalog No.	Description	Shipping Weight (lbs.)
	10128R	Stainless Steel	1.0

Hazardous Location Photo Cell Kit	Catalog No.	Description	Shipping Weight (lbs.)
	HLPC-120	Automatic on-off switch at predetermined light levels. (120 volt only)	1.0
	HLPC-208-277	REQUIRES FIELD INSTALLATION	1.0



An Avail Infrastructure Solutions Company

availinfra.com/rig-a-lite

8500 Hansen Road
Houston, TX 77075
(713) 943-0340