

EHRL LED

Hazardous-rated LED high-bay lighting for challenging environments

RIG-A-LITE™
An Avail Infrastructure Solutions Company

E-SERIES

Cost-effective, energy-efficient lighting for demanding environments

The RIG-A-LITE E-Series provides economical lighting solutions for industrial and hazardous applications, offering reliable performance and durability.

Classifications

- Class I, Division 2, Groups A, B, C, & D
- Class II, Division 1 & 2, Groups E, F & G
- Class III
- Class I, Zone 2, Group IIC
- Zone 21, Zone 22
- UL 844 Hazardous Locations
- UL 1598 Wet Locations
- UL 1598A Marine Outside Type
- UL 8750 LED Safety
- CSA C22.2 No. 137-M1981
- CSA C22.2 No. 250.0-08
- NEMA 4X
- IP67
- IK09
- 5G
- Resistant up to 2000 PSI of hose directed water
- Tested to 1000 hrs salt spray to standard ASTM"B117-11"

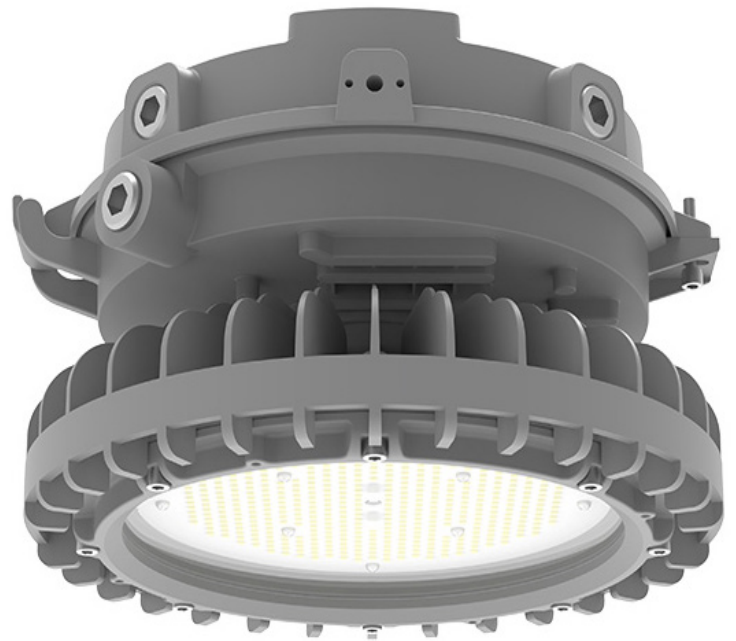

availinfra.com/rig-a-lite

8500 Hansen Road
Houston, TX 77075
(713) 943-0340

EHRL LED

Hazardous-rated LED high-bay lighting for challenging environments

Key Features

- 1 Easy Installation - Single barrel nut and hinge design, one-hand operation for quick and easy installation
- 2 Low Profile - 7.71" in height with maximum 34,000 lumen output fits perfectly in confined areas
- 3 High Efficacy - Lumen efficacy up to 170lm/W, reducing energy costs by up to 75% over conventional
- 4 Retrofit Friendly - Universal mounting accessories minimize the SKUs and maximize the flexibility
- 5 Built to Last - Copper-free aluminum and impact resistant lens provide ingress protection

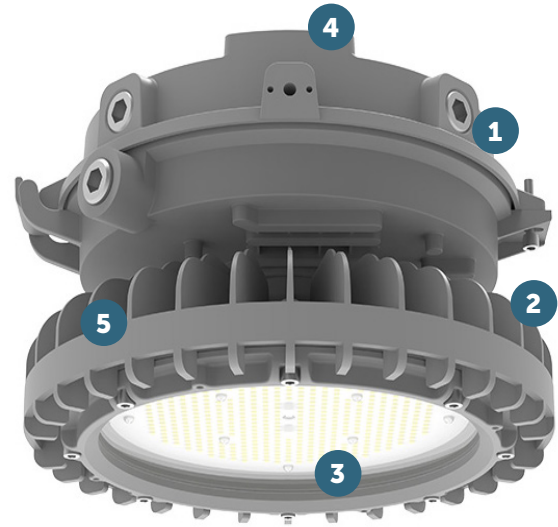

Additional Features

- Universal voltage: AC120-277, 347-480V (50/60Hz)
- Self-testing emergency battery backup for 40W and 60W
- High efficacy up to 170lm/W
- Optics: T1 / T3 / 110° beam angle
- CCT Adjustable (3000K/4000K/5000K)
- Wildlife-friendly amber color options
- 10kV surge protector is standard, 20kV optional
- Dimming: Standard 1-10VDC
- Ambient operating temperature -40°C to 65°C (standard model); 0°C to 50°C (emergency battery backup model)
- Lumen maintenance 150,000 @ L70
- 5-year warranty

Standard Materials

Body:

Housing, splice box, and adapter are die-cast copper-free aluminum with baked powder epoxy/polyester finish

Gaskets:

High temperature resistant silicone

Lens:

Heat, shock, and impact resistant glass or polycarbonate

Hardware:

Stainless Steel

EHRL LED

Hazardous-rated LED high-bay lighting for challenging environments

Catalog Number Logic

EHRL 07 - U - 2 - T1 - WW - TG - TB2 - GR - XX

1 2 3 4 5 6 7 8 9 10

1

BASIC LUMINAIRE

EHRL = N. American Standards

2

LUMENS/WATTS

07 = 6,800 Lumens / 40 Watts (EMSTD)
10 = 10,200 Lumens / 60 Watts (EMSTD)
14 = 13,600 Lumens / 80 Watts¹
17 = 17,000 Lumens / 100 Watts¹
26 = 25,500 Lumens / 150 Watts¹
34 = 32,000 Lumens / 200 Watts¹

3

VOLTAGE

U = 100-277V 50/60HZ
N = 347-480V 60HZ

4

PROTECTION LEVEL

2 = C1D2, C2D1
0 = Not Hazardous

5

OPTICS

110 = 110° Beam Angle
T1 = Type I
T3 = Type III

6

COLOR TEMPERATURE

WW = 2700K (Warm white)
SW = 3000K (Soft white)
NW = 4000K (Neutral white)
CW = 5000K (Cool white)
AM = Amber
AJC = Adjustable CCT
(3000K/4000K/5000K)

7

LENS

TG = Transparent Glass
FG = Frosted Glass
DFG = Frosted Drop Lens
TPL = Transparent Polycarbonate
FPL = Frosted Polycarbonate

8

MOUNTING STYLE

PD = Pendant mount (3/4" NPT)
PD2 = Pendant mount 1" NPT
TB2 = Trunnion bracket
FLM = Flush ceiling/wall mount
W90 = Wall mount 90°
W25 = Wall mount 25°
S90A = Stanchion-90° (1-1/4" NPT)
S90B = Stanchion-90° (1-1/2" NPT)
S25A = Stanchion-25° (1-1/4" NPT)
S25B = Stanchion-25° (1-1/2" NPT)

9

COLOR

GR = Gray

10

OPTIONS

WGR1 = Wire guard for flat glass
WGR2 = Wire guard for drop lens
SC1 = Safety cable
VRL25 = Dark sky bolt-on visor 25°
VRL90 = Dark sky bolt-on visor 90°
SP10U = 10KV surge protector
(100-277V) * Standard
SP10N = 10KV surge protector
(347-480V) * Standard
SP20U = 20KV surge protector (100-277V)
SP20N = 20KV surge protector (347-480V)
PBC48 = Pipe clamp (M8*48mm) for pole
1-7/8" (48mm) diameter
PBC60 = Pipe clamp (M8*60mm)
for pole 2-3/8" (60mm) diameter
CAB = 3' SEOOW-18/3 Cord
CGL = Cable gland 3/4" NPT
PS = Pole stanchion 2-3/8" (60mm)

¹ Self-testing emergency battery backup is not available on these models.

EHRL LED

Hazardous-rated LED high-bay lighting for challenging environments

Certification Guide

Model	Watts	Operating Voltage	Total Lumens ¹	Lumens per Watt ¹	CRI ¹	CCT ¹	Ambient Temperature ¹	Class I, Div. 2, Group A, B, C & D	Class II, Div. 1, Group E, F, G, Class III	Supply Wire Suitable Temperature, °C
EHRL07EM	40W	100-277V 50/60HZ	6800	170.0	70	5000K	0°C < Tamb < 50°C	T4A	T4A	90°C
EHRL10EM	60W	100-277V 50/60HZ	10200	170.0	70	5000K	0°C < Tamb < 50°C	T4A	T4A	90°C
EHRL14	80W	100-277V 50/60HZ, 347/480V 60HZ	13600	170.0	70	5000K	-40°C < Tamb < 65°C	T4A	T4A	90°C
EHRL17	100W	100-277V 50/60HZ, 347/480V 60HZ	17000	170.0	70	5000K	-40°C < Tamb < 65°C	T4A	T4A	90°C
EHRL26	150W	100-277V 50/60HZ, 347/480V 60HZ	25500	170.0	70	5000K	-40°C < Tamb < 65°C	T4A	T4A	90°C
EHRL34	200W	100-277V 50/60HZ, 347/480V 60HZ	32000	160.0	70	5000K	-40°C < Tamb < 60°C	T4	T4A	90°C

* Ambient temperature of all EMB option models is 0°C < Tamb < 50°C.

1. When frosted lenses or optics options are selected, total lumens, lumens per watt, CRI, CCT or ambient temperature may change. Consult factory for values.

EHRL LED

Hazardous-rated LED high-bay lighting for challenging environments

Photometric Data

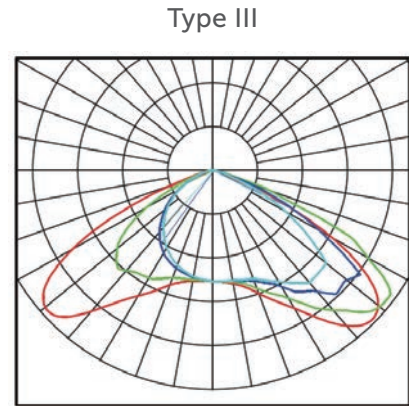
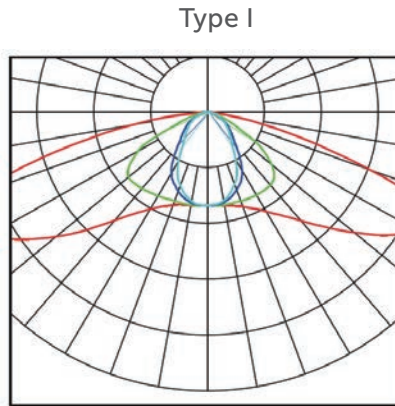
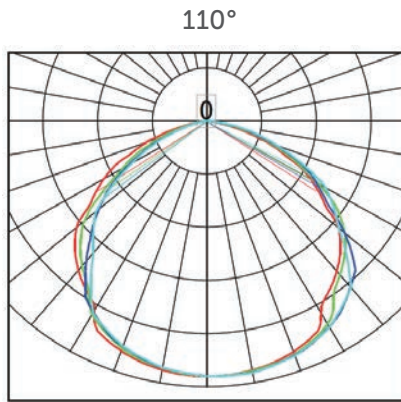

EHRL LED

Hazardous-rated LED high-bay lighting for challenging environments

Mounting Options

Pendant Mount: PD - 3/4" NPT / PD2 - 1" NPT



Fixture	Weight
EHRL07	17.86 lbs.
EHRL10	18.08 lbs.
EHRL14	16.98 lbs.
EHRL17	16.98 lbs.
EHRL26	17.20 lbs.
EHRL34	17.64 lbs.

Flush Ceiling Mount: FLM



Fixture	Weight
EHRL07	19.18 lbs.
EHRL10	19.40 lbs.
EHRL14	18.30 lbs.
EHRL17	18.30 lbs.
EHRL26	18.52 lbs.
EHRL34	18.96 lbs.

90° Stanchion Mount: S90A - 1-1/4" NPT

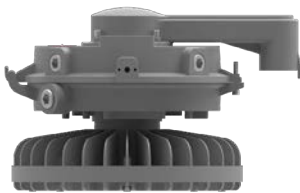

Fixture	Weight
EHRL07	19.84 lbs.
EHRL10	20.06 lbs.
EHRL14	18.96 lbs.
EHRL17	18.96 lbs.
EHRL26	19.18 lbs.
EHRL34	19.62 lbs.

25° Stanchion Mount: S90B - 1-1/2" NPT

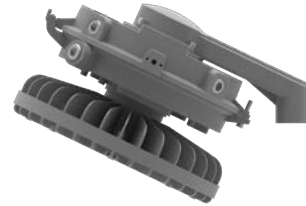

Fixture	Weight
EHRL07	19.84 lbs.
EHRL10	20.06 lbs.
EHRL14	18.96 lbs.
EHRL17	18.96 lbs.
EHRL26	19.18 lbs.
EHRL34	19.62 lbs.

For "EM" emergency option, add 1.47" in height

For Guard option, add 0.136" in height

No options for fixture without emergency backup. For 40W and 60W, EHRM models are recommended.

EHRL LED

Hazardous-rated LED high-bay lighting for challenging environments

Mounting Options

90° Wall Mount: W90 - 3/4" NPT

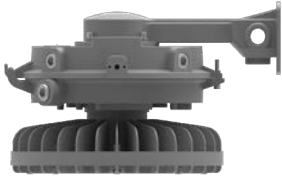

Fixture	Weight
EHRL07	20.94 lbs.
EHRL10	21.16 lbs.
EHRL14	20.06 lbs.
EHRL17	20.06 lbs.
EHRL26	20.28 lbs.
EHRL34	20.72 lbs.

Trunnion Bracket: TB2



Fixture	Weight
EHRL07	21.83 lbs.
EHRL10	22.05 lbs.
EHRL14	20.94 lbs.
EHRL17	20.94 lbs.
EHRL26	21.16 lbs.
EHRL34	21.61 lbs.

25° Wall Mount: W25 - 3/4" NPT



Fixture	Weight
EHRL07	20.94 lbs.
EHRL10	21.16 lbs.
EHRL14	20.06 lbs.
EHRL17	20.06 lbs.
EHRL26	20.28 lbs.
EHRL34	20.72 lbs.

For "EM" emergency option, add 1.47" in height









For Guard option, add 0.136" in height





No options for fixture without emergency backup. For 40W and 60W, EHRM models are recommended.

EHRL LED

Hazardous-rated LED high-bay lighting for challenging environments

Accessories

	Catalog No.	Size (in.)	Shipping Weight (lbs.)
 <p>Trunnion Bracket</p>	TB2	12.53" x 9.65" x 2.76"	3.75 lbs.
 <p>Bolt-on Wire Guard (flat glass)</p>	WGR1	10.84" x 0.24"	0.33 lbs.
 <p>Stainless Steel Safety Cable</p>	SC1	39.4"	0.29 lbs.
 <p>Stainless Steel Wire Guard (drop lens)</p>	WGR2	10.84" x 1.89"	0.44 lbs.
 <p>Pipe Clamp for 1-7/8" Pole</p>	PBC48	0.32" x 1.89"	0.35 lbs.
 <p>Pipe Clamp for 2-3/8" Pole</p>	PBC60	0.32" x 2.36"	0.44 lbs.
 <p>Pole Stanchion</p>	PS	2.36"	5.51 lbs.
 <p>Stainless Steel Dark Sky Visor 90°</p>	VRL90	16.15" x 4.85"	1.32 lbs.
 <p>Stainless Steel Dark Sky Visor 25°</p>	VRL25	15.21" x 9.22"	1.32 lbs.

	Catalog No.	Size (in.)	Shipping Weight (lbs.)
 <p>3' SEOOW-18/3 Cord</p>	CAB	39.4"	0.21 lbs.
 <p>Cable Gland</p>	CGL	1.46" x 1.73"	0.06 lbs.
 <p>10KV Surge Protector</p> <p>* Standard</p>	SP10U 10KV (100-277V)	4.18" x 0.91" x 0.51" Without Wire	0.09 lbs.
	SP10N 10KV (347-480V)	4.33" x 0.99" x 0.71" Without Wire	0.11 lbs.
 <p>20KV Surge Protector</p>	SP20U 20KV (100-277V)	4.41" x 1.1" x 0.59" Without Wire	0.12 lbs.
	SP20N 20KV (347-480V)	4.33" x 1.18" x 0.71"	0.15 lbs.
 <p>Flush Ceiling Mount Kit</p>	FLM (1 pair)	3.74" x 3.15" x 0.95"	1.32 lbs.



An Avail Infrastructure Solutions Company

availinfra.com/rig-a-lite

8500 Hansen Road
Houston, TX 77075
(713) 943-0340