

HZALJ LED

LED area lighting for hazardous locations

RIG-A-LITE™
An Avail Infrastructure Solutions Company



Classifications

- Class I, Division 2, Groups A, B, C, & D
- Class II, Divisions 1 & 2, Groups E, F & G
- Class III
- Class I, Zone 2, Group IIA, IIB, IIC
- Zone 21
- Simultaneous Presence
- UL 1598A Marine Outside Type
- UL 1598 Wet Locations
- UL 8750 LED Safety
- UL 844 Hazardous Locations
- UL 924 Emergency Lighting
- Emergency Battery Backup

- -40°C to 70°C Ambient Temperature
- CSA C22.2 No. 250.0-08
- CSA C22.2 No. 137-M1981 (R2014)
- NEMA 4X
- ABS Type Approved
- IP66
- Tested to LM 79, LM 80
- Factory Sealed
- Build America, Buy America Act (BABA) Compliant
- Buy American Act (BAA) Compliant

IECEX

- Ex ec IIC T4 Gc
- -40°C ≤ Tamb ≤ 65°C, IP66
- Ex ec nC IIC T4 Gc
- -40°C ≤ Tamb ≤ 70°C, IP66

- Ex tb IIIC T135°C Db
- -40°C ≤ Tamb ≤ 70°C, IP66
- Certificate: IECEx UL 20.0110X

ATEX

- CE  II 3 G
- II 3 G Ex ec IIC T4 Gc
- -40°C ≤ Tamb ≤ 65°C, IP66
- II 3 G Ex ec nC IIC T4 Gc
- -40°C ≤ Tamb ≤ 70°C, IP66
- Certificate: UL 20 ATEX 2435X
- CE  II 2 D
- II 2 D Ex tb IIIC T135°C Db
- -40°C ≤ Tamb ≤ 70°C, IP66
- Certificate: UL 20 ATEX 2434X



availinfra.com/rig-a-lite

8500 Hansen Road
Houston, TX 77075
(713) 943-0340

HZALJ LED

LED area lighting for hazardous locations

Key Features

- 1 Low profile body, less than 5" high
- 2 Interchangeable optics with Type I, III, V and wide distribution options
- 3 Spring pressure connection terminal block
- 4 Field replaceable LED circuit boards and drivers with quick disconnects
- 5 Hinged mount for access to internal components
- 6 Optional trunnion mount with locking positions in 15 degree increments
- 7 Two (2) safety cable attachment points

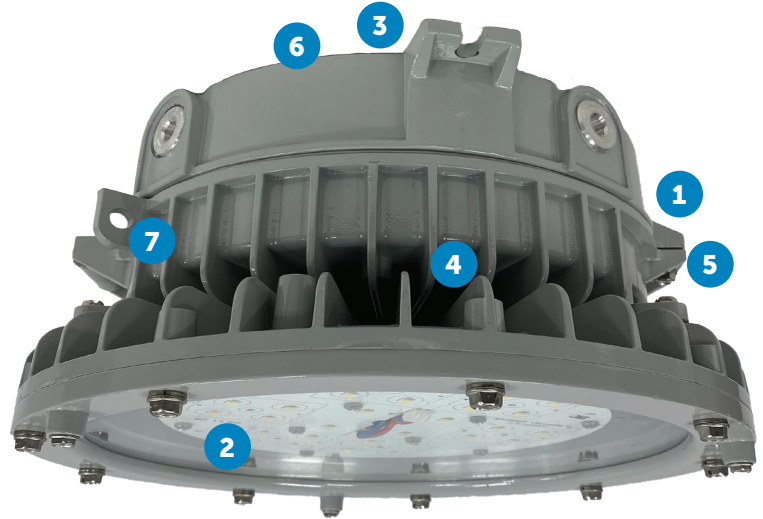

Additional Features

- Optional emergency backup with switching capability and field replaceable battery
- Pendant, ceiling, wall, trunnion and stanchion mounting options
- Mates directly to select competitor mounts
- Dimming option
- Optional Type 316 stainless steel guard
- Standard 10kV surge protection
- 5-year warranty

Standard Materials

Body:

A360 aluminum (less than .4% copper content) with baked-on gray epoxy finish

Gaskets:

One-Piece Silicone

Lens:

Tempered Glass or Polycarbonate

Hardware:

Stainless Steel

HZALJ LED

LED area lighting for hazardous locations

Catalog Number Logic

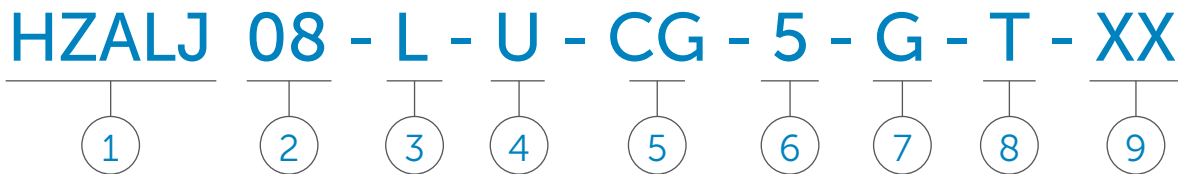

1

BASIC LUMINAIRE

HZALJ = N. American Standards
EXHZALJ = ATEX and IECEx Standards

2

LUMENS/WATTS

04 = 3,253 Lumens / 22 Watts
06 = 5,749 Lumens / 39 Watts
08 = 7,561 Lumens / 53 Watts
10 = 9,634 Lumens / 67 Watts
11 = 11,410 Lumens / 80 Watts
13 = 13,430 Lumens / 97 Watts
AM4 = Amber (4,150 Lumens / 57 Watts)
AM5 = Amber (4,895 Lumens / 85 Watts)

3

LAMP TYPE

L = LED (5000K CCT - White Light)*

4

DRIVER VOLTAGE

U = 120-277V 50/60HZ
D = 127-250 VDC³
N = 347/480V 60HZ³

5

LENS

CG = Clear Tempered Glass⁴
FG = Frosted Tempered Glass^{3,4}
CP = Clear Polycarbonate³

6

OPTICS

Blank = Type V
1 = Type I
3 = Type III
5 = Type V Wide Beam

7

GUARD

G = Stainless Wire Guard

8

MOUNTING STYLE

P = 3/4" Pendant Mount
P1 = 1" Pendant Mount
C = 3/4" Ceiling Mount
C1 = 1" Ceiling Mount
W = 3/4" Wall Mount
W1 = 1" Wall Mount
T = 3/4" Trunnion Mount
T1 = 1" Trunnion Mount
S = 1-1/4" 25° Stanchion
S1 = 1-1/2" 25° Stanchion
L = 1-1/4" 90° Stanchion
L1 = 1-1/2" 90° Stanchion

9

OPTIONS

EM = Emergency Battery Backup^{2,3}
FB1 = Single Fuse Block^{1,3}
FB2 = Double Fuse Block^{1,3}
SC = Safety Cable
30 = 3000K CCT*
40 = 4000K CCT*

¹ When selected, one fuse block is provided for 120V or 277V, two fuse blocks are provided for 208V – 240V or 480V. Fuse options not available with 347V, fixtures listed for use in Canada, marine listed fixtures or fixtures with EM option.

² EM Option not available with 347/480V or 127-250 VDC models.

³ Not available for EXHZALJ models.

⁴ Not for Class II use in Canada without suffix "G", guard.

Part numbering logic is for explaining catalog part structure only. Not all combinations are possible; consult factory for catalog numbers not listed on chart.

* Not available when amber light is selected.

HZALJ LED

LED area lighting for hazardous locations

Certification Guide

Model	Mount	Watts	Operating Voltage	Total Lumens ¹	Lumens per Watt ¹	CRI ¹	CCT ¹	Ambient Temperature ^{1,2}	Class I, Div. 2, Groups A, B, C & D	Class II, Div. 1, Groups E, F & G	Supply Wire Suitable Temperature, °C
HZALJ04LU	C, P, T, W, S, L	29W	120-277V 50/60HZ	3253	151.0	80.7	4910	-40°C < Tamb < 70°C	T4A	T4	90°C
HZALJ04LD	C, P, T, W, S, L	29W	127 - 250 VDC	3253	151.0	80.7	4910	-40°C < Tamb < 70°C	T4A	T4	90°C
HZALJ04LN	C, P, T, W, S, L	28W	347/480V 60HZ	3253	151.0	80.7	4910	-40°C < Tamb < 70°C	T4A	T4	90°C
HZALJ06LU	C, P, T, W, S, L	42W	120-277V 50/60HZ	5749	149.0	80.5	4918	-40°C < Tamb < 70°C	T4A	T4	90°C
HZALJ06LD	C, P, T, W, S, L	42W	127 - 250 VDC	5749	149.0	80.5	4918	-40°C < Tamb < 65°C	T4A	T4	90°C
HZALJ06LN	C, P, T, W, S, L	40W	347/480V 60HZ	5749	149.0	80.5	4918	-40°C < Tamb < 70°C	T4A	T4	90°C
HZALJ08LU	C, P, T, W, S, L	59W	120-277V 50/60HZ	7561	142.5	80.5	4960	-40°C < Tamb < 70°C	T4A	T4	90°C
HZALJ08LD	C, P, T, W, S, L	59W	127 - 250 VDC	7561	142.5	80.5	4960	-40°C < Tamb < 65°C	T4A	T4	90°C
HZALJ08LN	C, P, T, W, S, L	57W	347/480V 60HZ	7561	142.5	80.5	4960	-40°C < Tamb < 70°C	T4A	T4	90°C
HZALJ10LU	C, P, T, W, S, L	72W	120-277V 50/60HZ	9634	144.3	80.6	4896	-40°C < Tamb < 70°C	T4A	T4	90°C
HZALJ10LD	C, P, T, W, S, L	72W	127 - 250 VDC	9634	144.3	80.6	4896	-40°C < Tamb < 65°C	T4A	T4	90°C
HZALJ10LN	C, P, T, W, S, L	71W	347/480V 60HZ	9634	144.3	80.6	4896	-40°C < Tamb < 70°C	T4A	T4	90°C
HZALJ11LU	C, P, T, W, S, L	87W	120-277V 50/60HZ	11410	141.8	80.4	4968	-40°C < Tamb < 65°C	T4A	T4	90°C
HZALJ11LD	C, P, T, W, S, L	87W	127 - 250 VDC	11410	141.8	80.4	4968	-40°C < Tamb < 65°C	T4A	T4	90°C
HZALJ11LN	C, P, T, W, S, L	86W	347/480V 60HZ	11410	141.8	80.4	4968	-40°C < Tamb < 65°C	T4A	T4	90°C
HZALJ13LU	C, P, T, W, S, L	100W	120-277V 50/60HZ	13430	138.7	80.6	4959	-40°C < Tamb < 65°C	T4	T4	90°C
HZALJ13LD	C, P, T, W, S, L	100W	127 - 250 VDC	13430	138.7	80.6	4959	-40°C < Tamb < 65°C	T4	T4	90°C
HZALJ13LN	C, P, T, W, S, L	100W	347/480V 60HZ	13430	138.7	80.6	4959	-40°C < Tamb < 60°C	T4	T4	90°C
HZALJAM4LU	C, P, T, W, S, L	60W	120-277V 50/60HZ	4150	73.2	21.0	Amber	-40°C < Tamb < 65°C	T4	T4	90°C
HZALJAM4LD	C, P, T, W, S, L	60W	127 - 250 VDC	4150	73.2	21.0	Amber	-40°C < Tamb < 65°C	T4	T4	90°C
HZALJAM5LU	C, P, T, W, S, L	95W	120-277V 50/60HZ	4895	57.7	22.8	Amber	-40°C < Tamb < 65°C	T4	T4	90°C
HZALJAM5LD	C, P, T, W, S, L	95W	127 - 250 VDC	4895	57.7	22.8	Amber	-40°C < Tamb < 65°C	T4	T4	90°C
HZALJAM5LN	C, P, T, W, S, L	90W	347/480V 60HZ	4895	57.7	22.8	Amber	-40°C < Tamb < 55°C	T4	T4	90°C

1. For CG only, lumens/lumens per watt/CRI/CCT may change with CP, FG, or Optics. Consult factory for values.

2. Ambient temperature range is 0°C < Tamb < 55° when EM option is selected.

3. Watts, lumens, and lumens per watt will vary depending on actual ambient temperature.

HZALJ LED

LED area lighting for hazardous locations

Photometric Data

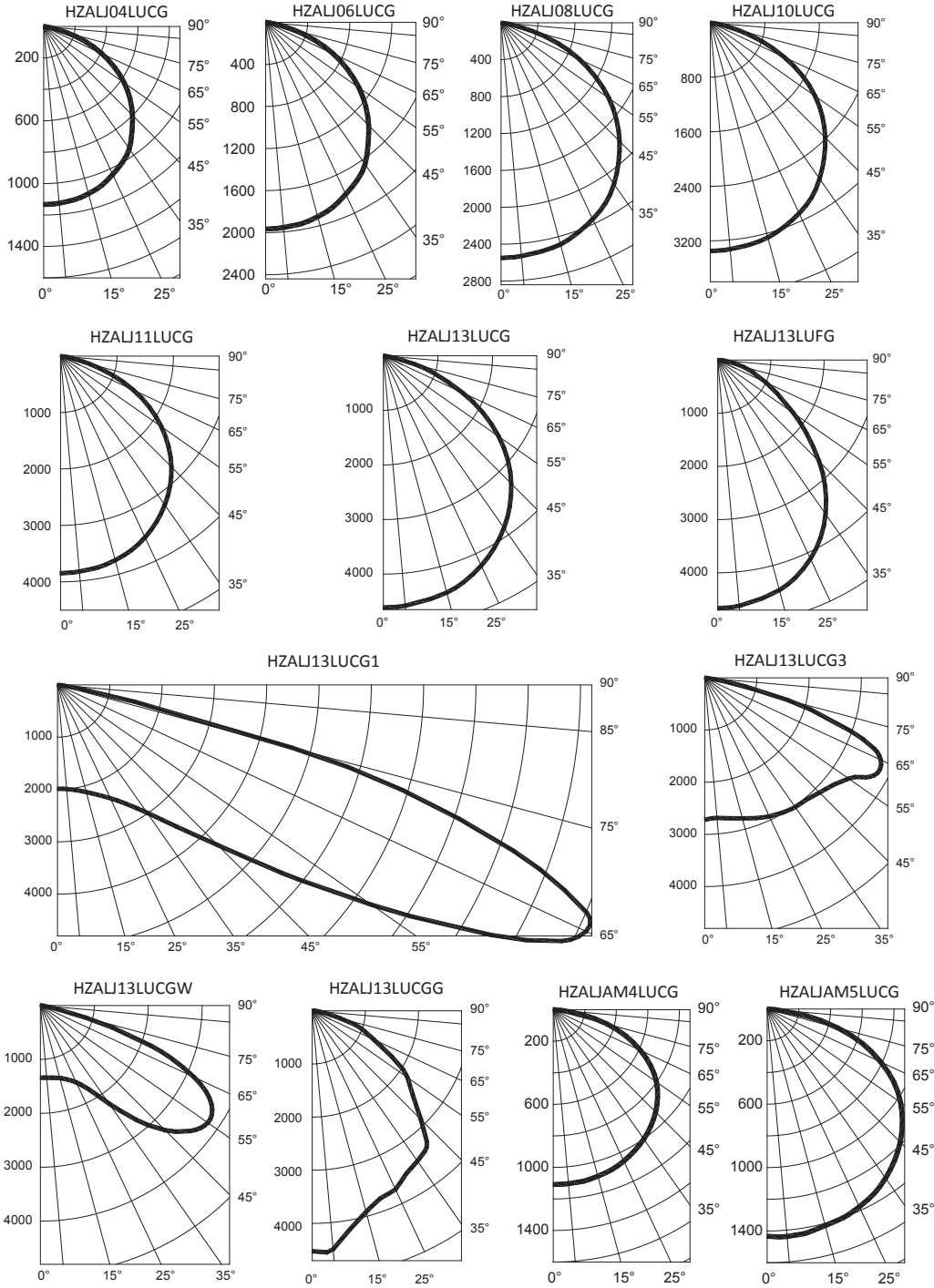

HZALJ LED

LED area lighting for hazardous locations

Fixture Dimensions (inches)

Pendant Mount

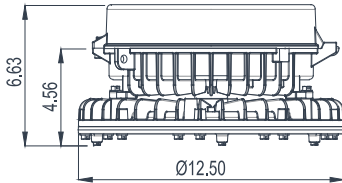

Fixture	Weight
HZALJ04LUCGP	13 lbs.
HZALJ06LUCGP	14 lbs.
HZALJ08LUCGP	14 lbs.
HZALJ10LUCGP	14 lbs.
HZALJ11LUCGP	14 lbs.
HZALJ13LUCGP	16 lbs.
HZALJAM4LUCGP	14 lbs.
HZALJAM5LUCGP	16 lbs.

Pendant Mount Emergency

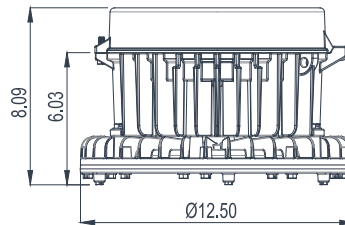

Fixture	Weight
HZALJ04LUCGPEM	20 lbs.
HZALJ06LUCGPEM	21 lbs.
HZALJ08LUCGPEM	21 lbs.
HZALJ10LUCGPEM	21 lbs.
HZALJ11LUCGPEM	21 lbs.
HZALJ13LUCGPEM	23 lbs.
HZALJAM4LUCGPEM	21 lbs.
HZALJAM5LUCGPEM	23 lbs.

Ceiling Mount

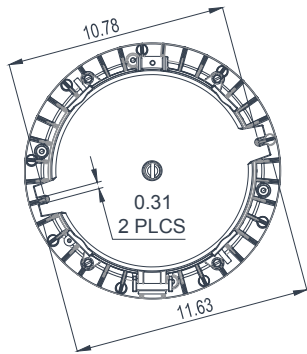

Fixture	Weight
HZALJ04LUCGC	14 lbs.
HZALJ06LUCGC	15 lbs.
HZALJ08LUCGC	15 lbs.
HZALJ10LUCGC	15 lbs.
HZALJ11LUCGC	15 lbs.
HZALJ13LUCGC	17 lbs.
HZALJAM4LUCGC	15 lbs.
HZALJAM5LUCGC	17 lbs.

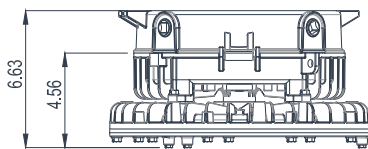

Wall Mount

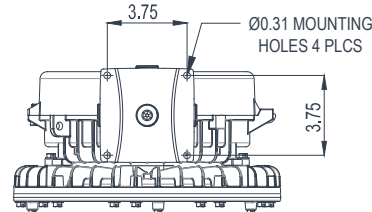

Fixture	Weight
HZALJ04LUCGW	16 lbs.
HZALJ06LUCGW	17 lbs.
HZALJ08LUCGW	17 lbs.
HZALJ10LUCGW	17 lbs.
HZALJ11LUCGW	17 lbs.
HZALJ13LUCGW	19 lbs.
HZALJAM4LUCGW	17 lbs.
HZALJAM5LUCGW	19 lbs.

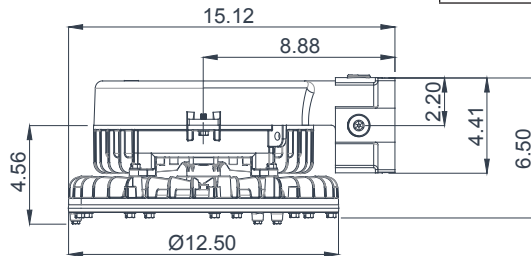

For "EM" emergency option, add 1.47" in height
 For Guard option, add 0.136" in height

HZALJ LED

LED area lighting for hazardous locations

Fixture Dimensions (inches)

90° Stanchion Mount

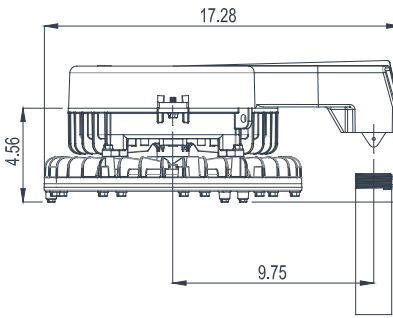

Fixture	Weight
HZALJ04LUCGL	16 lbs.
HZALJ06LUCGL	17 lbs.
HZALJ08LUCGL	17 lbs.
HZALJ10LUCGL	17 lbs.
HZALJ11LUCGL	17 lbs.
HZALJ13LUCGL	19 lbs.
HZALJAM4LUCGL	17 lbs.
HZALJAM5LUCGL	19 lbs.

Trunnion Mount

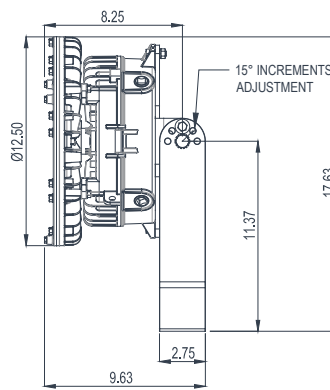

Fixture	Weight
HZALJ04LUCGT	18 lbs.
HZALJ06LUCGT	19 lbs.
HZALJ08LUCGT	19 lbs.
HZALJ10LUCGT	19 lbs.
HZALJ11LUCGT	19 lbs.
HZALJ13LUCGT	21 lbs.
HZALJAM4LUCGT	19 lbs.
HZALJAM5LUCGT	21 lbs.

25° Stanchion Mount

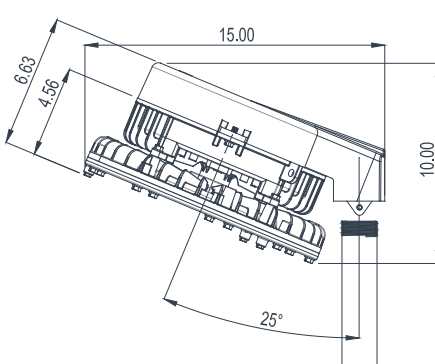

Fixture	Weight
HZALJ04LUCGS	16 lbs.
HZALJ06LUCGS	17 lbs.
HZALJ08LUCGS	17 lbs.
HZALJ10LUCGS	17 lbs.
HZALJ11LUCGS	17 lbs.
HZALJ13LUCGS	19 lbs.
HZALJAM4LUCGS	17 lbs.
HZALJAM5LUCGS	19 lbs.

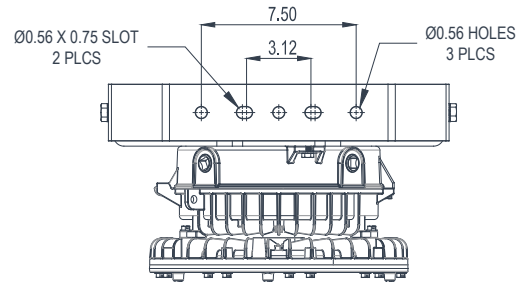

For "EM" emergency option, add 1.47" in height
 For Guard option, add 0.136" in height

HZALJ LED

LED area lighting for hazardous locations



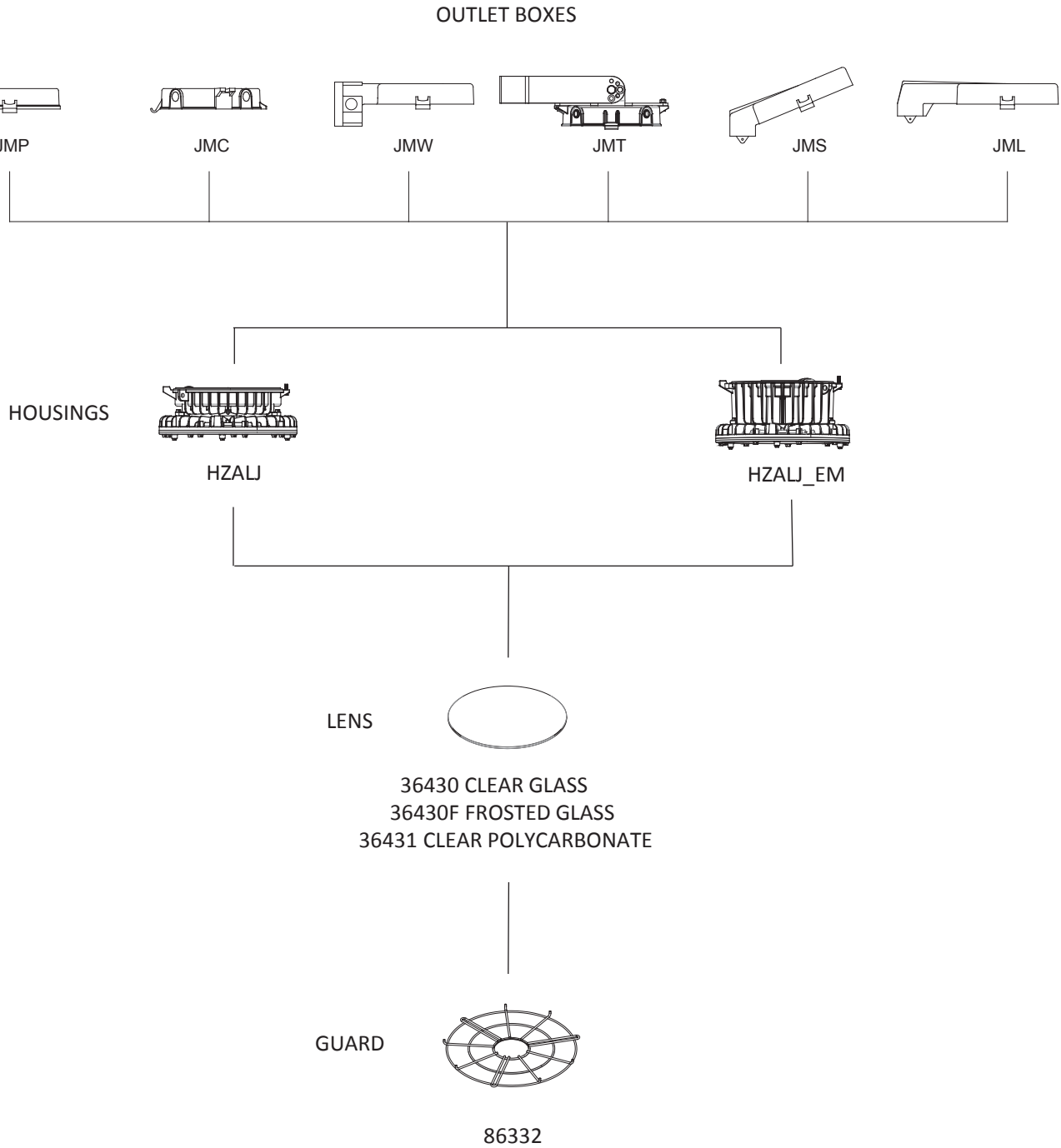

Configurations





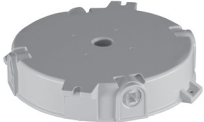

HZALJ LED

LED area lighting for hazardous locations

Accessories

Outlet Boxes	Catalog No.	Conduit Hub Size (in.)	Shipping Weight (lbs.)
Rigid Pendant 	JMP	3/4	3.0
	JMP1	1	3.0
Ceiling Mount 	JMC	3/4	3.5
	JMC1	1	3.5
Wall Mount 	JMW	3/4	6.0
	JMW1	1	6.0
Trunnion Mount 	JMT	3/4	8.0
	JMT1	1	8.0
25° Stanchion Mount 	JMS	1-1/4	5.0
	JMS1	1-1/2	5.0
90° Stanchion Mount 	JML	1-1/4	6.5
	JML1	1-1/2	6.5

Lenses	Catalog No.	Conduit Hub Size (in.)	Shipping Weight (lbs.)
	36430	Clear Tempered Glass	2.0
	36430F	Frosted Tempered Glass	2.0
	36431	Clear Polycarbonate	2.0

Stainless Steel Wire Guard	Catalog No.	Description	Shipping Weight (lbs.)
	86332	Stainless Steel	1.0

Stainless Steel Safety Cable	Catalog No.	Description	Shipping Weight (lbs.)
	10128R	Stainless Steel	1.0

Hazardous Location Photo Cell Kit	Catalog No.	Description	Shipping Weight (lbs.)
	HLPC-120	Automatic on-off switch at predetermined light levels. (120 volt only)	1.0
	HLPC-208-277	REQUIRES FIELD INSTALLATION	1.0



An Avail Infrastructure Solutions Company

availinfra.com/rig-a-lite

8500 Hansen Road
Houston, TX 77075
(713) 943-0340