

EHSL LED

Explosion-proof LED high-bay lighting for hazardous-rated environments

RIG-A-LITE™
An Avail Infrastructure Solutions Company

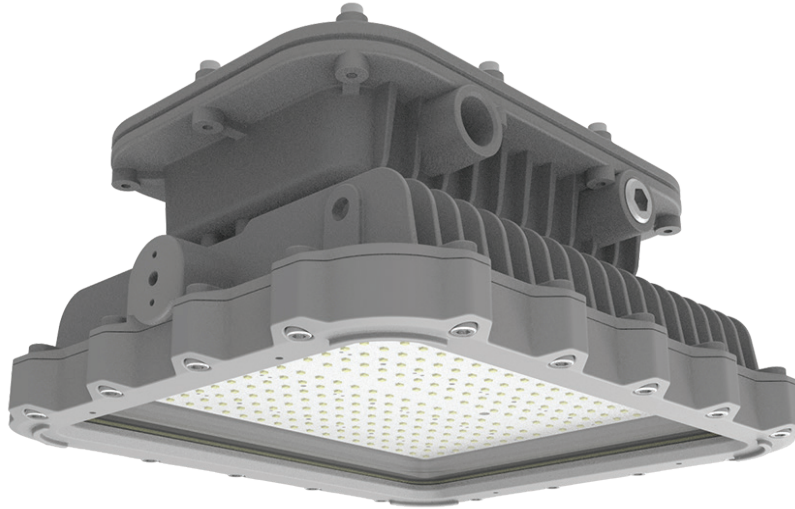

E-SERIES

Cost-effective, energy-efficient lighting for demanding environments

The RIG-A-LITE E-Series provides economical lighting solutions for industrial and hazardous applications, offering reliable performance and durability.

Classifications

- Class I, Division 1, Groups C & D
- Class I, Division 2, Groups A, B, C, & D
- Class II, Division 1, Groups E, F & G
- Class III
- Class I, Zone 1, Group IIB
- Class I, Zone 2, Group IIC
- Zone 21, Zone 22
- UL 844 Hazardous Locations
- UL 1598 Wet Locations
- UL 1598A Marine Outside Type
- UL 8750 LED Safety
- Paint Spray Booth
- CSA C22.2 No. 137-M1981
- CSA C22.2 No. 250.0-08
- NEMA 4X
- IP67
- IK09
- 5G
- Resistant up to 2,000 PSI hose directed water
- Tested to 1000 hrs salt spray to standard ASTM"B117-11"



availinfra.com/rig-a-lite

8500 Hansen Road,
Houston, TX 77075
(713) 943-0340

EHSL LED

Explosion-proof LED high-bay lighting for hazardous-rated environments

Key Features

- 1** Lightweight Design - Optimized design, balanced well for weight, safety, and durability
- 2** Easy Installation - Hinge design makes installation easier and safer for both retrofit and new construction
- 3** High Lumen Output - Provides up to 160 lm/W and maintains the same light intensity with less power intensity
- 4** Multiple Beam Angles - 30°, 60°, 90°, 110°, T2, T3, T4 lenses provide more choices for different scenarios
- 5** Adjustable U-bracket - 360° bracket provides flexibility in angle adjustment and passed 5G 3-axis vibration test

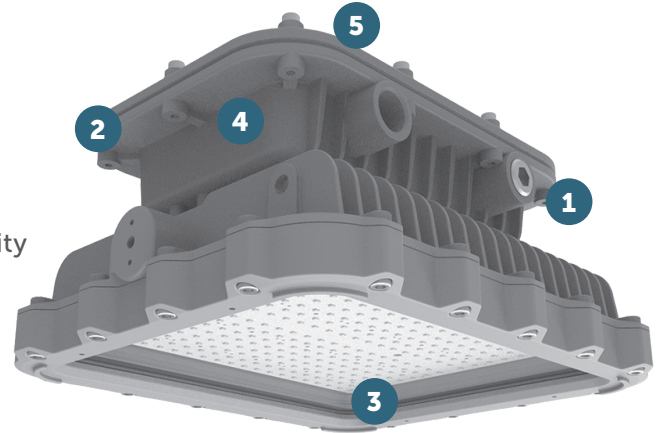

Additional Features

- Universal voltage: AC120-277, 347-480V (50/60Hz)
- High efficacy up to 160 lm/W, up to 32,000lm
- Optics: 30° / 60° / 90° / 110° / T2 / T3 / T4
- CCT Adjustable (3000K/4000K/5000K)
- Wildlife-friendly amber color options
- 10kV surge protector is standard, 20kV optional
- Dimming: Standard 1-10VDC
- T-rating of T6
- Ambient operating temperature -40°C to 60°C
- Lumen maintenance 150,000 @ L70
- Optional self-testing emergency battery backup for non-hazardous applications
- 5-year warranty

Standard Materials

Body:

Housing, splice box, and adapter are die-cast copper-free aluminum with baked powder epoxy/polyester finish

Gaskets:

High temperature resistant silicone

Lens:

Heat, shock, and impact resistant clear or diffused glass

Hardware:

Stainless Steel with lacquer-free nameplate

EHSL LED

Explosion-proof LED high-bay lighting for hazardous-rated environments

Catalog Number Logic

EHSL 13 - U - 2 - 30 - WW - TG - TB1 - GR - XX



1

BASIC LUMINAIRE

EHSL = N. American Standards

2

LUMENS/WATTS

13 = 12,800 Lumens / 80 Watts
16 = 16,000 Lumens / 100 Watts
24 = 24,000 Lumens / 150 Watts
32 = 32,000 Lumens / 200 Watts

3

VOLTAGE

U = 100-277V 50/60HZ
N = 347-480V 60HZ

4

PROTECTION LEVEL

1 = C1D1, C2D1
2 = C1D2, C2D1

5

OPTICS

30 = 30° Beam Angle
60 = 60° Beam Angle
90 = 90° Beam Angle
110 = 110° Beam Angle
T2 = Type II
T3 = Type III
T4 = Type IV

6

COLOR TEMPERATURE

WW = 2700K (Warm white)
SW = 3000K (Soft white)
NW = 4000K (Neutral white)
CW = 5000K (Cool white)
AM = Amber
AJC = Adjustable CCT
(3000K/4000K/5000K)

7

LENS

TG = Transparent Glass
FG = Frosted Glass

8

MOUNTING STYLE

PD = Pendant mount (3/4" NPT)
TB1 = Trunion bracket (EHSL)
CJB = Ceiling junction box
W25 = Wall bracket 25°
W90 = Wall mount 90°
W25 = Wall mount 25°
S90A = Stanchion-90° (1-1/4" NPT)
S90B = Stanchion-90° (1-1/2" NPT)
S25A = Stanchion-25° (1-1/4" NPT)
S25B = Stanchion-25° (1-1/2" NPT)

9

COLOR

GR = Gray

10

OPTIONS

WGS1 = Wire guard
SC1 = Safety cable 8 (4mm)
VS1 = Dark sky visor
SP10U = 10KV surge protector
(100-277V) * Standard
SP10N = 10KV surge protector
(347-480V) * Standard
SP20U = 20KV surge protector (100-277V)
SP20N = 20KV surge protector (347-480V)
PBC48 = Pipe clamp (M8*48mm) for pole
1-7/8" (48mm) diameter
PBC60 = Pipe clamp (M8*60mm) for pole
2-3/8" (60mm) diameter
CAB = 3' SEOWW-18/3 cord
CGL = Cable gland 3/4" NPT
TJB = Twin-mount junction box
PS = Pole stanchion 2-3/8" (60mm)

EHSL LED

Explosion-proof LED high-bay lighting for hazardous-rated environments

Certification Guide

Model	Watts	Operating Voltage	Total Lumens ¹	Lumens per Watt ¹	CRI ¹	CCT ¹	Ambient Temperature ¹	Class I, Div. 1, Group C & D	Class I, Div. 2, Group A, B, C & D	Class II, Div. 1, Group E, F, G, Class III	Supply Wire Suitable Temperature, °C
EHSL13	80W	100-277V 50/60HZ, 347/480V 60HZ	12800	160.0	70	5000K	-40°C < Tamb < 65°C	T6	T4A	T4A	90°C
EHSL16	100W	100-277V 50/60HZ, 347/480V 60HZ	16000	160.0	70	5000K	-40°C < Tamb < 65°C	T6	T4A	T4A	90°C
EHSL24	150W	100-277V 50/60HZ, 347/480V 60HZ	24000	160.0	70	5000K	-40°C < Tamb < 65°C	T6	T4A	T4A	90°C
EHSL32	200W	100-277V 50/60HZ, 347/480V 60HZ	32000	160.0	70	5000K	-40°C < Tamb < 60°C	T6	T4A	T4	90°C

* Ambient temperature of all EMB option models is 0°C < Tamb < 50°C. EMB option is only available with 100-277V 50/60HZ.

1. When FG or optics options are selected, total lumens, lumens per watt, CRI, CCT or ambient temperature may change. Consult factory for values.

EHSL LED

Explosion-proof LED high-bay lighting for hazardous-rated environments

Photometric Data

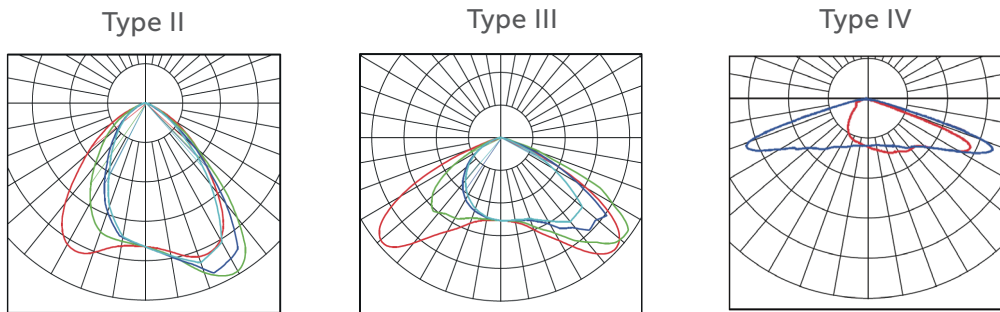
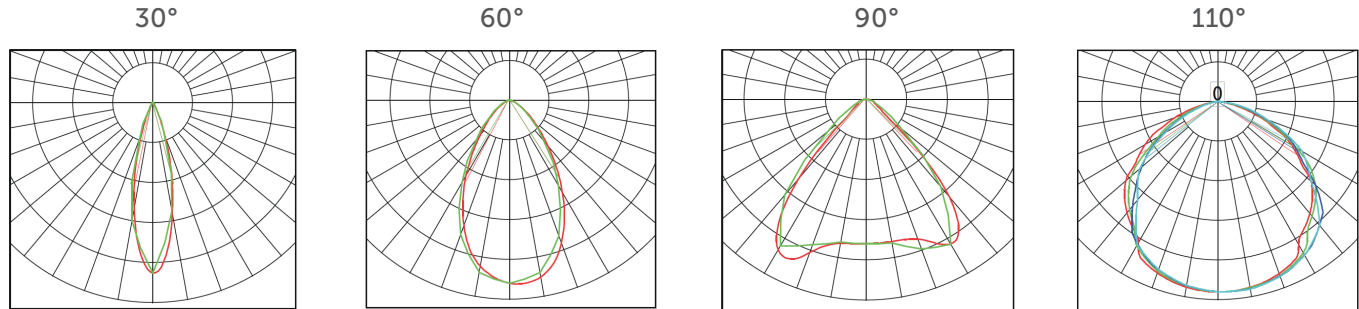

EHSL LED

Explosion-proof LED high-bay lighting for hazardous-rated environments

Mounting Options

Pendant Mount (Standard): PD - 3/4" NPT

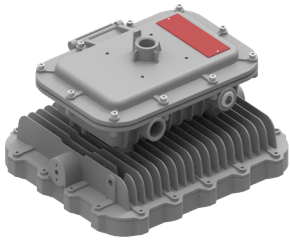

Fixture	Weight
EHSL13	25.35 lbs.
EHSL16	25.35 lbs.
EHSL24	25.57 lbs.
EHSL32	25.79 lbs.

Junction Box: CJB - 3/4" NPT

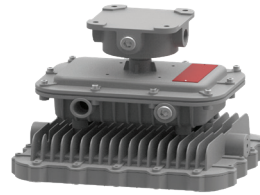

Fixture	Weight
EHSL13	27.56 lbs.
EHSL16	27.56 lbs.
EHSL24	27.78 lbs.
EHSL32	28.00 lbs.

90° Wall Mount: W90 - 3/4" NPT

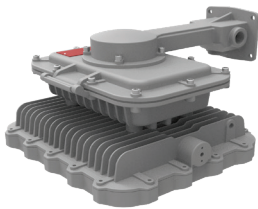

Fixture	Weight
EHSL13	28.44 lbs.
EHSL16	28.44 lbs.
EHSL24	28.66 lbs.
EHSL32	28.88 lbs.

25° Wall Mount: W25 - 3/4" NPT

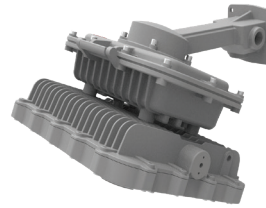

Fixture	Weight
EHSL13	28.44 lbs.
EHSL16	28.44 lbs.
EHSL24	28.66 lbs.
EHSL32	28.88 lbs.

EHSL LED

Explosion-proof LED high-bay lighting for hazardous-rated environments

Mounting Options (continued)

90° Stanchion: S90A - 1-1/4" / S90B - 1-1/4" NPT

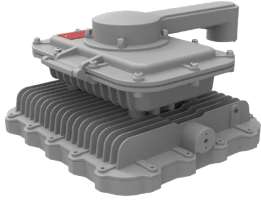

Fixture	Weight
EHSL13	27.34 lbs.
EHSL16	27.34 lbs.
EHSL24	27.56 lbs.
EHSL32	27.78 lbs.

Trunnion Bracket: TB1 - 3/4" NPT



Fixture	Weight
EHSL13	27.56 lbs.
EHSL16	27.56 lbs.
EHSL24	28.00 lbs.
EHSL32	28.22 lbs.

25° Stanchion: S25A - 1-1/4" / S25B - 1-1/4" NPT

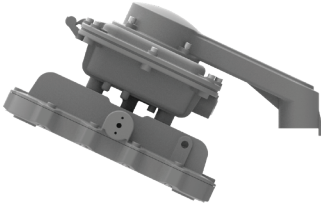









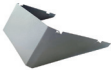

Fixture	Weight
EHSL13	27.34 lbs.
EHSL16	27.34 lbs.
EHSL24	27.56 lbs.
EHSL32	27.78 lbs.

EHSL LED

Explosion-proof LED high-bay lighting for hazardous-rated environments

Accessories

	Catalog No.	Size (in.)	Shipping Weight (lbs.)
Trunnion Bracket 	TB1	14.18" x 8.08" x 2.76"	3.31 lbs.
Stainless Steel Wire Guard 	WGS1	12.21" x 9.06" x 0.24"	0.37 lbs.
Stainless Steel Safety Cable 	SC1	39.4"	0.29 lbs.
Stainless Steel Dark Sky Visor 	VS1	12.53" x 9.38" x 4.33"	1.20 lbs.
Pipe Clamp for 1-7/8" Pole 	PBC48	0.32" x 1.89"	0.35 lbs.
Pipe Clamp for 2-3/8" Pole 	PBC60	0.32" x 2.36"	0.44 lbs.
Pole Stanchion 	PS	2.36"	5.51 lbs.

	Catalog No.	Size (in.)	Shipping Weight (lbs.)
3' SEOWW-18/3 Cord 	CAB	39.4"	0.21 lbs.
Cable Gland 	CGL	1.46" x 1.73"	0.06 lbs.
10KV Surge Protector  * Standard	SP10U 10KV (100-277V)	4.18" x 0.91" x 0.51" Without Wire	0.09 lbs.
	SP10N 10KV (347-480V)	4.33" x 0.99" x 0.71" Without Wire	0.11 lbs.
20KV Surge Protector 	SP20U 20KV (100-277V)	4.41" x 1.1" x 0.59" Without Wire	0.12 lbs.
	SP20N 20KV (347-480V)	4.33" x 1.18" x 0.71" Without Wire	0.15 lbs.



An Avail Infrastructure Solutions Company

availinfra.com/rig-a-lite

8500 Hansen Road
Houston, TX 77075
(713) 943-0340