

# IALJ Hi-Lumen LED

## LED area lighting for industrial locations

### Fixture Dimensions (inches)

#### Pendant Mount

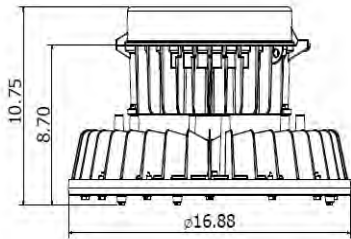

Fixture	Weight
IALJ15LUCGP	27 lbs.
IALJ18LUCGP	28 lbs.
IALJ20LUCGP	28 lbs.
IALJ23LUCGP	28 lbs.
IALJ25LUCGP	28 lbs.
IALJ28LUCGP	29 lbs.
IALJ30LUCGP	29 lbs.

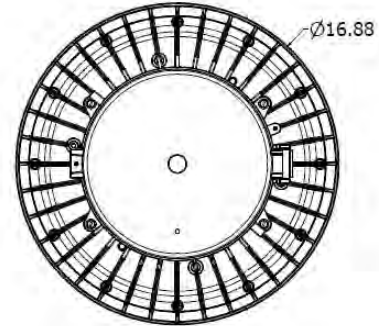

#### Ceiling Mount

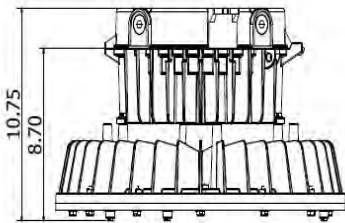

Fixture	Weight
IALJ15LUCGP	28 lbs.
IALJ18LUCGP	29 lbs.
IALJ20LUCGP	29 lbs.
IALJ23LUCGP	29 lbs.
IALJ25LUCGP	29 lbs.
IALJ28LUCGP	30 lbs.
IALJ30LUCGP	30 lbs.

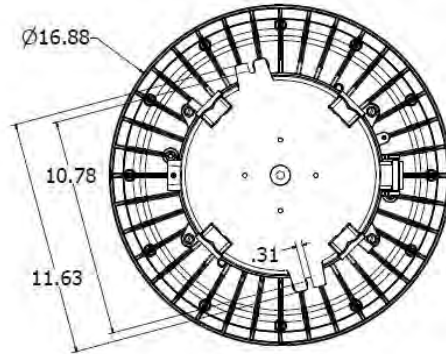

#### 90° Stanchion Mount

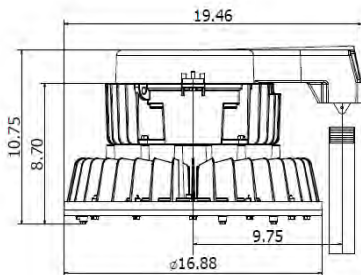

Fixture	Weight
IALJ15LUCGP	30 lbs.
IALJ18LUCGP	31 lbs.
IALJ20LUCGP	31 lbs.
IALJ23LUCGP	31 lbs.
IALJ25LUCGP	31 lbs.
IALJ28LUCGP	32 lbs.
IALJ30LUCGP	32 lbs.

# IALJ Hi-Lumen LED

## LED area lighting for industrial locations

### Fixture Dimensions (inches)

#### 25° Stanchion Mount

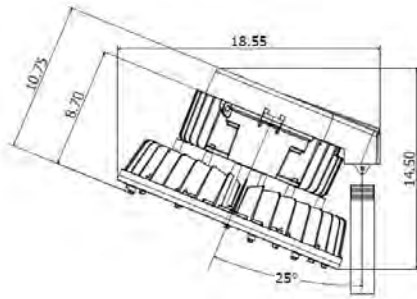

Fixture	Weight
IALJ15LUCGP	30 lbs.
IALJ18LUCGP	31 lbs.
IALJ20LUCGP	31 lbs.
IALJ23LUCGP	31 lbs.
IALJ25LUCGP	31 lbs.
IALJ28LUCGP	32 lbs.
IALJ30LUCGP	32 lbs.

#### Trunnion Mount

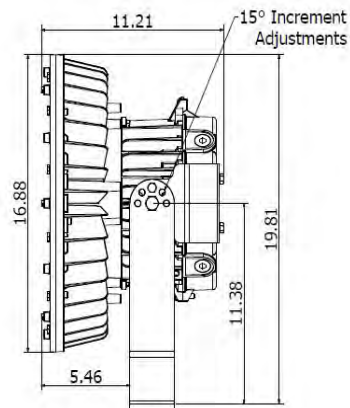

Fixture	Weight
IALJ15LUCGP	31 lbs.
IALJ18LUCGP	32 lbs.
IALJ20LUCGP	32 lbs.
IALJ23LUCGP	32 lbs.
IALJ25LUCGP	32 lbs.
IALJ28LUCGP	33 lbs.
IALJ30LUCGP	33 lbs.

