

# HZALJ Hi-Lumen LED

## LED area lighting for hazardous locations

### Fixture Dimensions (inches)

#### Pendant Mount

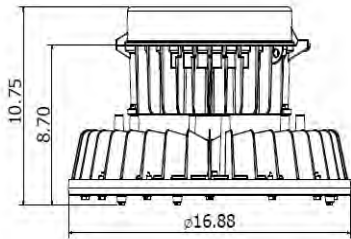

Fixture	Weight
HZALJ15LUCGP	27 lbs.
HZALJ18LUCGP	28 lbs.
HZALJ20LUCGP	28 lbs.
HZALJ23LUCGP	28 lbs.
HZALJ25LUCGP	28 lbs.
HZALJ28LUCGP	29 lbs.
HZALJ30LUCGP	29 lbs.

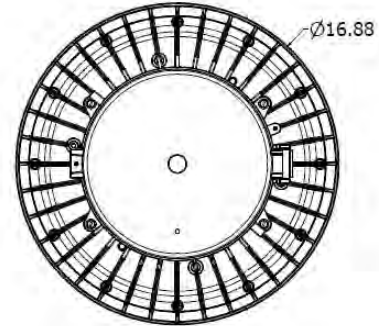

#### Ceiling Mount

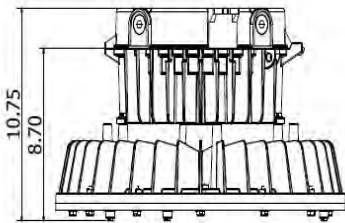

Fixture	Weight
HZALJ15LUCGP	28 lbs.
HZALJ18LUCGP	29 lbs.
HZALJ20LUCGP	29 lbs.
HZALJ23LUCGP	29 lbs.
HZALJ25LUCGP	29 lbs.
HZALJ28LUCGP	30 lbs.
HZALJ30LUCGP	30 lbs.

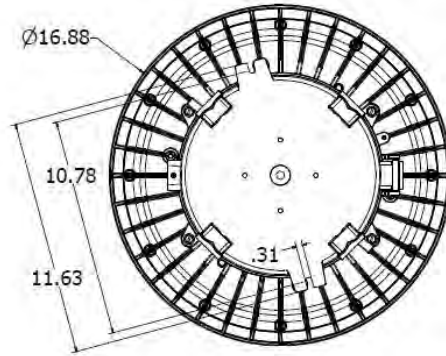

#### 90° Stanchion Mount

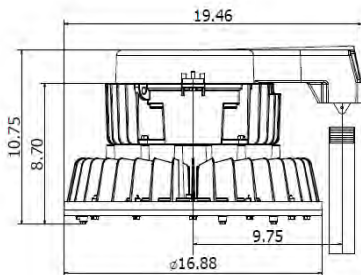

Fixture	Weight
HZALJ15LUCGP	30 lbs.
HZALJ18LUCGP	31 lbs.
HZALJ20LUCGP	31 lbs.
HZALJ23LUCGP	31 lbs.
HZALJ25LUCGP	31 lbs.
HZALJ28LUCGP	32 lbs.
HZALJ30LUCGP	32 lbs.

# HZALJ Hi-Lumen LED

## LED area lighting for hazardous locations

### Fixture Dimensions (inches)

#### 25° Stanchion Mount

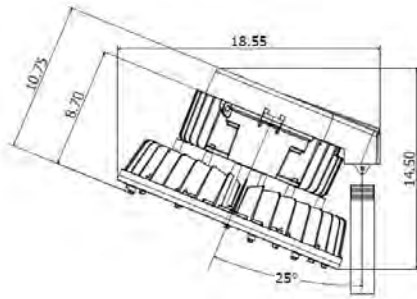

Fixture	Weight
HZALJ15LUCGP	30 lbs.
HZALJ18LUCGP	31 lbs.
HZALJ20LUCGP	31 lbs.
HZALJ23LUCGP	31 lbs.
HZALJ25LUCGP	31 lbs.
HZALJ28LUCGP	32 lbs.
HZALJ30LUCGP	32 lbs.

#### Trunnion Mount

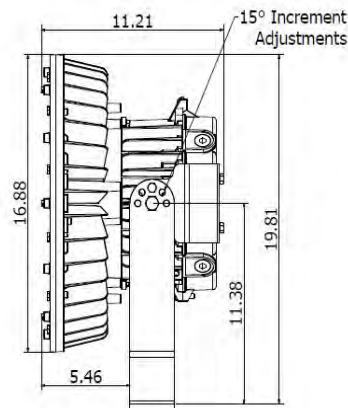

Fixture	Weight
HZALJ15LUCGP	31 lbs.
HZALJ18LUCGP	32 lbs.
HZALJ20LUCGP	32 lbs.
HZALJ23LUCGP	32 lbs.
HZALJ25LUCGP	32 lbs.
HZALJ28LUCGP	33 lbs.
HZALJ30LUCGP	33 lbs.

