

XHBF LED

Explosion proof LED area lighting

RIG-A-LITE™
An Avail Infrastructure Solutions Company



Classifications

- Class I, Division 1, Groups B, C & D
- Class II, Division 1, Groups E, F & G
- Class III
- Simultaneous Presence
- Class I, Zone 1 AEx db IIB+H2 T5 Gb
- Class II, Zone 21 AEx tb IIIC 100°C Db
- UL 1598A Marine Outside Type
- UL 1598 Wet Locations
- UL 8750 LED Safety
- UL 844 Hazardous Locations
- Emergency Battery Backup
- -40°C to 65°C Ambient Temp.
- CSA C22.2 No. 250.0-08
- CSA C22.2 No. 137-M1981
- NEMA 4X
- ABS Type Approved
- IP66
- Paint Spray Booth
- Tested to LM79 & LM80
- **IECEx**
Ex db op is IIB+H2 T5 Gb
-40°C ≤ Tamb ≤ 65°C, IP66
Ex op is tb IIIC T100°C Db
-40°C ≤ Tamb ≤ 55°C, IP66
Certificate: IECEx ITS 19.0026X
- **ATEX**
CE (Ex) II 2 G D
Ex db op is IIB+H2 T5 Gb
-40°C ≤ Tamb ≤ 65°C, IP66
Ex op is tb IIIC T100°C Db
-40°C ≤ Tamb ≤ 55°C, IP66
Certificate: ETL22ATEX0137X

availinfra.com/rig-a-lite

8500 Hansen Road,
Houston, TX 77075
(713) 943-0340

XHBF LED

Explosion proof LED area lighting

Key Features

- 1 Low profile body, less than 7" high
- 2 Interchangeable optics with Type I, III, V, medium, wide, narrow and very narrow distribution options
- 3 Spring pressure connection terminal block
- 4 Field replaceable LED circuit boards and drivers with quick disconnects
- 5 Optional trunnion mount with five locking positions in 15 degree increments
- 6 Two (2) safety cable attachment points with optional eye-bolts



Additional Features

- Certified for hydrogen atmospheres (Group B)
- Emergency Battery Backup option with switching capability
- Mates directly to SXP/SXPJ HID mounts
- 0-10V dimming, range 10-100%
- Standard 10kV surge protection
- 5-year warranty

Standard Materials

Body:

A360 aluminum (less than .4% copper content) with baked-on gray epoxy finish

Gaskets:

One-Piece Silicone

Lens:

Tempered Glass

Hardware:

Stainless Steel

XHBF LED

Explosion proof LED area lighting

Catalog Number Logic

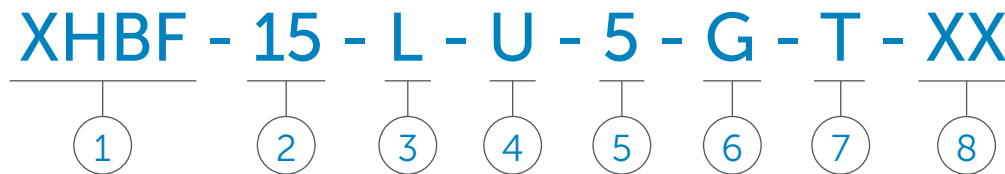

- 1**
BASIC LUMINAIRE
XHBF = North American Standards
EXHBF = ATEX and IECEx Standards
- 2**
LAMP WATTAGE
15 = 135 Watt
14 = 120 Watt
13 = 105 Watt
12 = 96 Watt
11 = 87 Watt
09 = 77 Watt
08 = 60 Watt
06 = 45 Watt
- 3**
LAMP TYPE
L = LED (5000K CCT)
- 4**
VOLTAGE/FREQUENCY
U = 100-277V 50/60HZ
N = 347/480V 50/60HZ
- 5**
OPTICS
Blank = Type V Medium
1 = Type I
3 = Type III
N = Type V Narrow Beam
5 = Type V Wide Beam
VN = Type V Very Narrow
- 6**
Guard
G = Stainless Steel Wire Guard
- 7**
MOUNTING STYLE
P = 3/4" Pendant Mount
P1 = 1" Pendant Mount
C = 3/4" Ceiling Mount
C1 = 1" Ceiling Mount
W = 3/4" Wall Mount³
W1 = 1" Wall Mount³
T = Trunnion Mount
TP = Trunnion 3/4" Pendant Mount
- 5**
OPTICS
EB = Eye Bolts (2)
EM = Emergency Battery Backup^{1,4}
FB1 = Single Fuse Block²
FB2 = Double Fuse Block²
30 = 3000K CCT
40 = 4000K CCT

¹ EM option not available with 347/480V or EXHBF models.

² When selected one fuse block is provided for 120 or 277V, two fuse blocks/fuses are provided for 208-240V or 480V. Fuse options not available for 347V, fixtures listed for use in Canada, marine listed fixtures or fixtures with EM option.

³ Not available on XHBF models.

⁴ 10.4 watts delivered for 90 minutes.

Catalog logic is for explaining catalog number structure only. Not all combinations are possible; consult factory for catalog numbers not listed in charts..

XHBF LED

Explosion proof LED area lighting

XHBF LED Fixture Dimensions (inches)

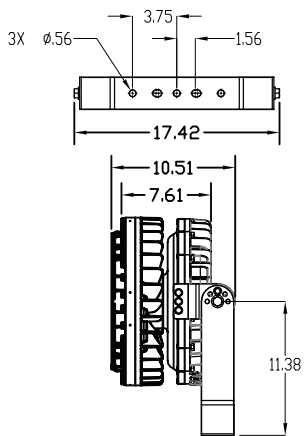

TRUNNION MOUNT

Fixture	Fixture Weight	Shipping Weight
XHBF15LUT	50 lbs	55 lbs
XHBF14LUT	50 lbs	55 lbs
XHBF13LUT	50 lbs	55 lbs
XHBF12LUT	50 lbs	55 lbs
XHBF11LUT	49 lbs	54 lbs
XHBF09LUT	49 lbs	54 lbs
XHBF08LUT	49 lbs	54 lbs
XHBF06LUT	49 lbs	54 lbs

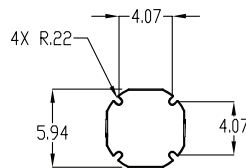

CEILING MOUNT

Fixture	Fixture Weight	Shipping Weight
XHBF15LUC	51 lbs	56 lbs
XHBF14LUC	51 lbs	56 lbs
XHBF13LUC	51 lbs	56 lbs
XHBF12LUC	51 lbs	56 lbs
XHBF11LUC	50 lbs	55 lbs
XHBF09LUC	50 lbs	55 lbs
XHBF08LUC	50 lbs	55 lbs
XHBF06LUC	50 lbs	55 lbs

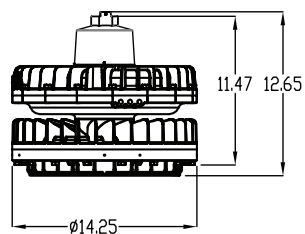
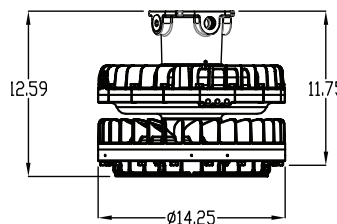

PENDANT MOUNT

Fixture	Fixture Weight	Shipping Weight
XHBF15LUP	49 lbs	54 lbs
XHBF14LUP	49 lbs	54 lbs
XHBF13LUP	49 lbs	54 lbs
XHBF12LUP	49 lbs	54 lbs
XHBF11LUP	48 lbs	53 lbs
XHBF09LUP	48 lbs	53 lbs
XHBF08LUP	48 lbs	53 lbs
XHBF06LUP	48 lbs	53 lbs

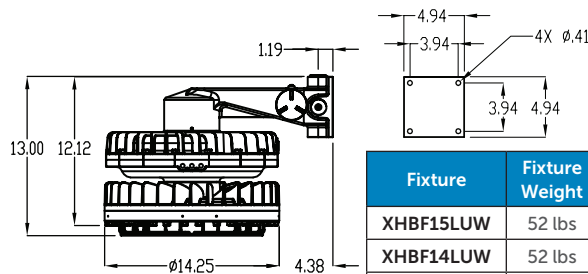

WALL MOUNT

Fixture	Fixture Weight	Shipping Weight
XHBF15LUW	52 lbs	57 lbs
XHBF14LUW	52 lbs	57 lbs
XHBF13LUW	52 lbs	57 lbs
XHBF12LUW	52 lbs	57 lbs
XHBF11LUW	51 lbs	56 lbs
XHBF09LUW	51 lbs	56 lbs
XHBF08LUW	51 lbs	56 lbs
XHBF06LUW	51 lbs	56 lbs

XHBF LED

Explosion proof LED area lighting

XHBF Certification Guide

Model	Mount	Wattage	Operating Voltage	Total Lumens ¹	Lumens per Watt ¹	CRI ¹	CCT ¹	Ambient Temperature ^{1,2}	Class I, Div. 1, Group B, C & D	Class II, Div. 1, Group E, F & G, Class III	Simultaneous Presence	Paint Spray Booth	Supply Wire Suitable Temperature, °C
XHBF15L	C, P, T	135W	120V - 277V 50/60 Hz 347V/480V 60Hz	15400	115	80	5367	-40°C < Tamb < 65°C	T5	-	-	Yes	90°C
XHBF15L	C, P, T	135W	120V - 277V 50/60 Hz 347V/480V 60Hz	15400	115	80	5367	-40°C < Tamb < 55°C	T5	100°C	T5	Yes	90°C
XHBF14L	C, P, T	120W	120V - 277V 50/60 Hz 347V/480V 60Hz	13680	115	80	5390	-40°C < Tamb < 65°C	T5	-	-	Yes	90°C
XHBF14L	C, P, T	120W	120V - 277V 50/60 Hz 347V/480V 60Hz	13680	115	80	5390	-40°C < Tamb < 55°C	T5	100°C	T5	Yes	90°C
XHBF13L	C, P, T	105W	120V - 277V 50/60 Hz 347V/480V 60Hz	12600	119	80	5360	-40°C < Tamb < 65°C	T5	-	-	Yes	90°C
XHBF13L	C, P, T	105W	120V - 277V 50/60 Hz 347V/480V 60Hz	12600	119	80	5360	-40°C < Tamb < 55°C	T5	100°C	T5	Yes	90°C
XHBF12L	C, P, T	96W	120V - 277V 50/60 Hz 347V/480V 60Hz	11360	118	80	5345	-40°C < Tamb < 65°C	T5	-	-	Yes	90°C
XHBF12L	C, P, T	96W	120V - 277V 50/60 Hz 347V/480V 60Hz	11360	118	80	5345	-40°C < Tamb < 55°C	T5	100°C	T5	Yes	90°C
XHBF11L	C, P, T	87W	120V - 277V 50/60 Hz 347V/480V 60Hz	10750	124	80	5353	-40°C < Tamb < 65°C	T5	-	-	Yes	90°C
XHBF11L	C, P, T	87W	120V - 277V 50/60 Hz 347V/480V 60Hz	10750	124	80	5353	-40°C < Tamb < 55°C	T5	100°C	T5	Yes	90°C
XHBF09L	C, P, T	77W	120V - 277V 50/60 Hz 347V/480V 60Hz	9691	126	80	5313	-40°C < Tamb < 65°C	T5	-	-	Yes	90°C
XHBF09L	C, P, T	77W	120V - 277V 50/60 Hz 347V/480V 60Hz	9691	126	80	5313	-40°C < Tamb < 55°C	T5	100°C	T5	Yes	90°C
XHBF08L	C, P, T	60W	120V - 277V 50/60 Hz 347V/480V 60Hz	7735	129	80	5340	-40°C < Tamb < 65°C	T5	-	-	Yes	90°C
XHBF08L	C, P, T	60W	120V - 277V 50/60 Hz 347V/480V 60Hz	7735	129	80	5340	-40°C < Tamb < 55°C	T5	100°C	T5	Yes	90°C
XHBF06L	C, P, T	45W	120V - 277V 50/60 Hz 347V/480V 60Hz	5812	130	80	5372	-40°C < Tamb < 65°C	T5	-	-	Yes	90°C
XHBF06L	C, P, T	45W	120V - 277V 50/60 Hz 347V/480V 60Hz	5812	130	80	5372	-40°C < Tamb < 55°C	T5	100°C	T5	Yes	90°C
XHBF15LXX1	C, P, T	135W	120V - 277V 50/60 Hz 347V/480V 60Hz	13591	97	80	5409	-40°C < Tamb < 55°C	T5	100°C	T5	Yes	90°C
XHBF15LXX3	C, P, T	135W	120V - 277V 50/60 Hz 347V/480V 60Hz	13500	101	81	5460	-40°C < Tamb < 55°C	T5	100°C	T5	Yes	90°C
XHBF15LXXN	C, P, T	135W	120V - 277V 50/60 Hz 347V/480V 60Hz	15040	112	80	5374	-40°C < Tamb < 55°C	T5	100°C	T5	Yes	90°C
XHBF15LUXVH	C, P, T	135W	120V - 277V 50/60 Hz 347V/480V 60Hz	15100	113	80	5313	-40°C < Tamb < 55°C	T5	100°C	T5	Yes	90°C
XHBF15LXX5	C, P, T	135W	120V - 277V 50/60 Hz 347V/480V 60Hz	13390	100	80	5397	-40°C < Tamb < 55°C	T5	100°C	T5	Yes	90°C

¹ When optics options are selected, total lumens, lumens per watt, CRI, CCT or ambient temperature may change. Consult factory for values.

² Ambient temperature range is 0°C < Tamb < 40°C when EM option is selected.

XHBF LED

Explosion proof LED area lighting

EXHBF Certification Guide

Model	Mount	Wattage	Operating Voltage	Total Lumens ¹	Lumens per Watt ¹	CRI ¹	CCT ¹	Ambient Temperature ¹	Ex db	Ex tb
EXHBF15L	C, P, T, W	135W	120V - 277V 50/60 Hz 347V/480V 60Hz	15400	115	80	5367	-40°C < Tamb < 65°C	T5	-
EXHBF15L	C, P, T, W	135W	120V - 277V 50/60 Hz 347V/480V 60Hz	15400	115	80	5367	-40°C < Tamb < 55°C	T5	100°C
EXHBF14L	C, P, T, W	120W	120V - 277V 50/60 Hz 347V/480V 60Hz	13680	115	80	5390	-40°C < Tamb < 65°C	T5	-
EXHBF14L	C, P, T, W	120W	120V - 277V 50/60 Hz 347V/480V 60Hz	13680	115	80	5390	-40°C < Tamb < 55°C	T5	100°C
EXHBF13L	C, P, T, W	105W	120V - 277V 50/60 Hz 347V/480V 60Hz	12600	119	80	5360	-40°C < Tamb < 65°C	T5	-
EXHBF13L	C, P, T, W	105W	120V - 277V 50/60 Hz 347V/480V 60Hz	12600	119	80	5360	-40°C < Tamb < 55°C	T5	100°C
EXHBF12L	C, P, T, W	96W	120V - 277V 50/60 Hz 347V/480V 60Hz	11360	118	80	5345	-40°C < Tamb < 65°C	T5	-
EXHBF12L	C, P, T, W	96W	120V - 277V 50/60 Hz 347V/480V 60Hz	11360	118	80	5345	-40°C < Tamb < 55°C	T5	100°C
EXHBF11L	C, P, T, W	87W	120V - 277V 50/60 Hz 347V/480V 60Hz	10750	124	80	5353	-40°C < Tamb < 65°C	T5	-
EXHBF11L	C, P, T, W	87W	120V - 277V 50/60 Hz 347V/480V 60Hz	10750	124	80	5353	-40°C < Tamb < 55°C	T5	100°C
EXHBF09L	C, P, T, W	77W	120V - 277V 50/60 Hz 347V/480V 60Hz	9691	126	80	5313	-40°C < Tamb < 65°C	T5	-
EXHBF09L	C, P, T, W	77W	120V - 277V 50/60 Hz 347V/480V 60Hz	9691	126	80	5313	-40°C < Tamb < 55°C	T5	100°C
EXHBF08L	C, P, T, W	60W	120V - 277V 50/60 Hz 347V/480V 60Hz	7735	129	80	5340	-40°C < Tamb < 65°C	T5	-
EXHBF08L	C, P, T, W	60W	120V - 277V 50/60 Hz 347V/480V 60Hz	7735	129	80	5340	-40°C < Tamb < 55°C	T5	100°C
EXHBF06L	C, P, T, W	45W	120V - 277V 50/60 Hz 347V/480V 60Hz	5812	130	80	5372	-40°C < Tamb < 65°C	T5	-
EXHBF06L	C, P, T, W	45W	120V - 277V 50/60 Hz 347V/480V 60Hz	5812	130	80	5372	-40°C < Tamb < 55°C	T5	100°C
EXHBF15LXX1	C, P, T, W	135W	120V - 277V 50/60 Hz 347V/480V 60Hz	13591	97	80	5409	-40°C < Tamb < 55°C	T5	100°C
EXHBF15LXX3	C, P, T, W	135W	120V - 277V 50/60 Hz 347V/480V 60Hz	13500	101	80	5460	-40°C < Tamb < 55°C	T5	100°C
EXHBF15LXXN	C, P, T, W	135W	120V - 277V 50/60 Hz 347V/480V 60Hz	15040	112	80	5374	-40°C < Tamb < 55°C	T5	100°C
EXHBF15LUXVNI	C, P, T, W	135W	120V - 277V 50/60 Hz 347V/480V 60Hz	15100	113	80	5313	-40°C < Tamb < 55°C	T5	100°C
EXHBF15LXX5	C, P, T, W	135W	120V - 277V 50/60 Hz 347V/480V 60Hz	13390	100	80	5397	-40°C < Tamb < 55°C	T5	100°C

¹ When optics options are selected, total lumens, lumens per watt, CRI, CCT or ambient temperature may change. Consult factory for values

XHBF LED

Explosion proof LED area lighting

Candlepower Distribution

XHBF06LUM

Deg.	0	22.5	45	67.5	90
0	2086	2086	2086	2086	2086
10	2057	2057	2057	2057	2057
20	1975	1975	1975	1975	1975
30	1833	1833	1833	1833	1833
40	1608	1608	1608	1608	1608
50	1328	1328	1328	1328	1328
60	887	887	887	887	887
70	440	440	440	440	440
80	77	77	77	77	77
90	0	0	0	0	0

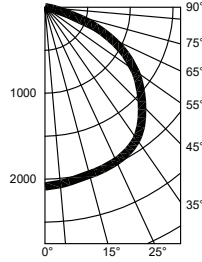

XHBF08LUM

Deg.	0	22.5	45	67.5	90
0	2771	2771	2771	2771	2771
10	2735	2735	2735	2735	2735
20	2635	2635	2635	2635	2635
30	2442	2442	2442	2442	2442
40	2140	2140	2140	2140	2140
50	1766	1766	1766	1766	1766
60	1182	1182	1182	1182	1182
70	586	586	586	586	586
80	105	105	105	105	105
90	0	0	0	0	0

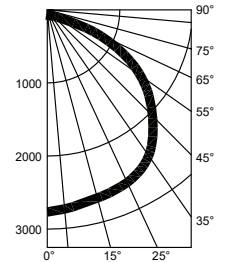

XHBF09LUM

Deg.	0	22.5	45	67.5	90
0	3472	3472	3472	3472	3472
10	3428	3428	3428	3428	3428
20	3301	3301	3301	3301	3301
30	3059	3059	3059	3059	3059
40	2681	2681	2681	2681	2681
50	2212	2212	2212	2212	2212
60	1479	1479	1479	1479	1479
70	733	733	733	733	733
80	130	130	130	130	130
90	2	2	2	2	2

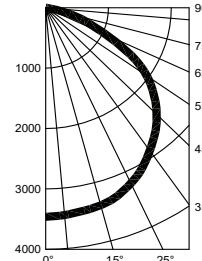

XHBF11LUM

Deg.	0	22.5	45	67.5	90
0	3852	3852	3852	3852	3852
10	3803	3803	3803	3803	3803
20	3665	3665	3665	3665	3665
30	3397	3397	3397	3397	3397
40	2977	2977	2977	2977	2977
50	2457	2457	2457	2457	2457
60	1640	1640	1640	1640	1640
70	810	810	810	810	810
80	145	145	145	145	145
90	0	0	0	0	0

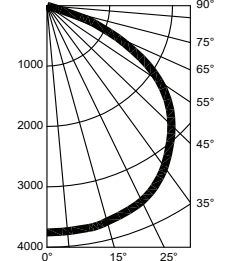

XHBF12LUM

Deg.	0	22.5	45	67.5	90
0	4057	4057	4057	4057	4057
10	4014	4014	4014	4014	4014
20	3858	3858	3858	3858	3858
30	3574	3574	3574	3574	3574
40	3160	3160	3160	3160	3160
50	2599	2599	2599	2599	2599
60	1748	1748	1748	1748	1748
70	838	838	838	838	838
80	143	143	143	143	143
90	1	1	1	1	1

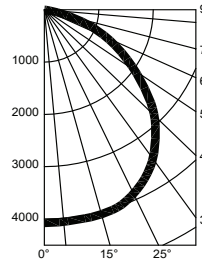

XHBF13LUM

Deg.	0	22.5	45	67.5	90
0	4535	4535	4535	4535	4535
10	4489	4489	4489	4489	4489
20	4311	4311	4311	4311	4311
30	3980	3980	3980	3980	3980
40	3515	3515	3515	3515	3515
50	2875	2875	2875	2875	2875
60	1926	1926	1926	1926	1926
70	923	923	923	923	923
80	160	160	160	160	160
90	0	0	0	0	0

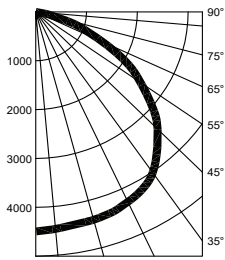

XHBF14LUM

Deg.	0	22.5	45	67.5	90
0	4859	4859	4859	4859	4859
10	4815	4815	4815	4815	4815
20	4665	4665	4665	4665	4665
30	4334	4334	4334	4334	4334
40	3820	3820	3820	3820	3820
50	3129	3129	3129	3129	3129
60	2098	2098	2098	2098	2098
70	1011	1011	1011	1011	1011
80	173	173	173	173	173
90	0	0	0	0	0

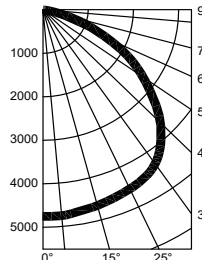

XHBF LED

Explosion proof LED area lighting

Candlepower Distribution

XHBF15LUM

Deg.	0.	22.5	45	67.5	90
0	5527	5527	5527	5527	5527
10	5473	5473	5473	5473	5473
20	5257	5257	5257	5257	5257
30	4852	4852	4852	4852	4852
40	4288	4288	4288	4288	4288
50	3515	3515	3515	3515	3515
60	2366	2366	2366	2366	2366
70	1133	1133	1133	1133	1133
80	195	195	195	195	195
90	2	2	2	2	2

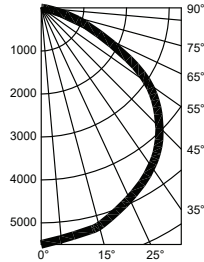

XHBF15LUM1

Deg.	0.	22.5	45	67.5	90
0	2041	2041	2041	2041	2041
10	2104	2087	2058	2031	2020
20	2343	2259	2096	1976	1926
30	2781	2578	2171	1888	1771
40	3790	3124	2256	1775	1573
50	6427	4041	2256	1628	1387
60	12650	4795	1925	1218	1030
70	10480	2551	926	670	590
80	667	166	98	82	85
90	0	0	0	0	0

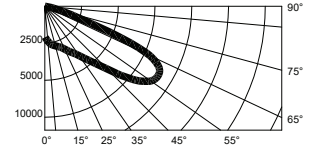

XHBF15LUM3

Deg.	0.	22.5	45	67.5	90
0	2981	2981	2981	2981	2981
10	4107	4125	3825	3408	2980
20	4801	4846	4699	4096	3082
30	5577	5780	5511	4970	3250
40	5087	5566	6525	6081	3475
50	3990	4496	6980	7472	4125
60	1625	1797	5372	8125	4944
70	676	675	1798	5339	3156
80	130	130	199	540	290
90	1	1	2	4	5

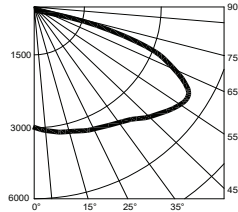

XHBF15LUM5

Deg.	0.	22.5	45	67.5	90
0	1262	1262	1262	1262	1262
10	1296	1295	1290	1291	1292
20	1449	1455	1465	1458	1454
30	1877	1927	1976	1951	1905
40	2534	2703	2838	2808	2692
50	3308	3728	4119	3772	3358
60	3113	3964	4895	3643	2942
70	1597	2399	3285	2249	1643
80	131	172	499	197	140
90	0	0	0	0	0

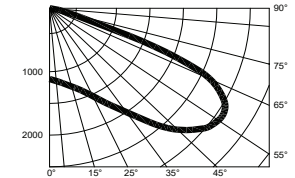

XHBF15LUMN

Deg.	0.	22.5	45	67.5	90
0	15210	15210	15210	15210	15210
10	14060	14090	14100	14150	14190
20	11090	11070	10970	11070	11190
30	6180	6364	6643	6565	6460
40	2670	2777	2816	2876	2761
50	1396	1384	1391	1419	1427
60	802	781	782	805	839
70	386	380	397	401	418
80	86	89	89	88	95
90	1	2	2	1	2

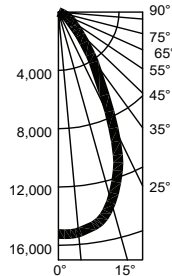

XHBF15LUMVN

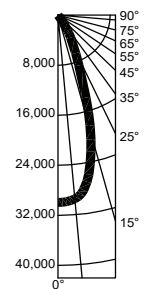

Deg.	0.	22.5	45	67.5	90
0	30550	30550	30550	30550	30550
10	25790	25790	25790	25790	25790
20	11710	11710	11710	11710	11710
30	3907	3907	3907	3907	3907
40	1549	1549	1549	1549	1549
50	1008	1008	1008	1008	1008
60	732	732	732	732	732
70	414	414	414	414	414
80	93	93	93	93	93
90	0	0	0	0	0





XHBF LED

Explosion proof LED area lighting

Accessories

Outlet Boxes	Description	Hub Size	Catalog Number	Shipping Weight (lbs.)
	Pendant	3/4 1	SXPP SXPP1	2.15 2.15
	Ceiling	3/4 1	SXPC SXPC1	4.0 4.0
	Wall	3/4 1	SXPW SXPW1	6.20 6.20

Stainless Steel Wire Guard	Catalog Number	Shipping Weight (lbs.)
	86339	1.0

Trunnion Kit	Catalog Number	Shipping Weight (lbs.)
	26903	5.0

Optic Kits	Description	Catalog Number	Shipping Weight (lbs.)
	Type I	86071	1.0
	Type III	86073	1.0
	Wide	86072	1.0
	Narrow	86074	1.0
	Very Narrow	86075	1.0

Stainless Steel Safety Cable	Catalog Number	Shipping Weight (lbs.)
	10128R	1.0



An Avail Infrastructure Solutions Company

availinfra.com/rig-a-lite

8500 Hansen Road,
Houston, TX 77075
(713) 943-0340